



Module 6: Understanding processes and assessing energy performance of textile and garment factories

Prepared by: Dr. Jurgen Hannak, M. Salman Butt



LU 6.1: Energy Performance in Textile Process

At the end of this module you will be able to...

Assess and conduct energy balance of textile and garments processes

Resources

[IFC Environmental, Health, and Safety Guidelines for Textile Manufacturing](#)

Content

- Typical production and process flows in Spinning, Weaving, Dyeing, Finishing and Garment Making
- Input-output aspects
- Key performance benchmarks
- Energy balance of Textile and Garment processes
- EE Opportunities in processes

Textile Value Chain

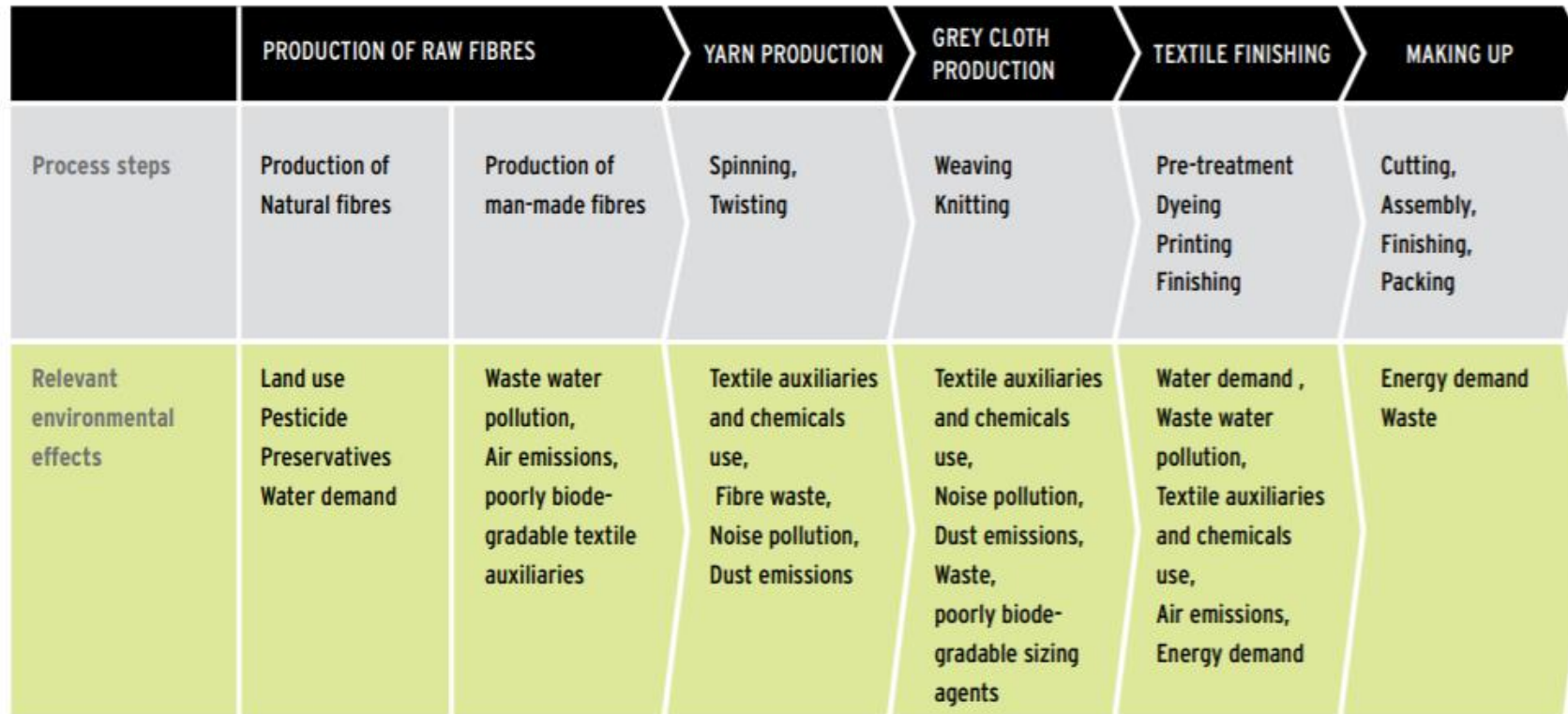

Yarn manufacturing/ Spinning



Yarn Production

Group work

- In your groups, develop typical energy flows and losses in Yarn Production process using the I.P.O. diagram.
- Present your results on flip chart in Information Market format
- Time 15 min

Yarn Production (aka Spinning)

Example Material Flow Chart

QC 1	Mixing, Plucking, Blending
QC 2	Multimix, Beating
QC 3	Sorting, Beating, Scutcher
QC 4	Carding
QC 5	Breaker Drawing
QC 6	Finisher Drawing
QC 7	Simplex
QC 8	Ring
QC 9	Auto Cone

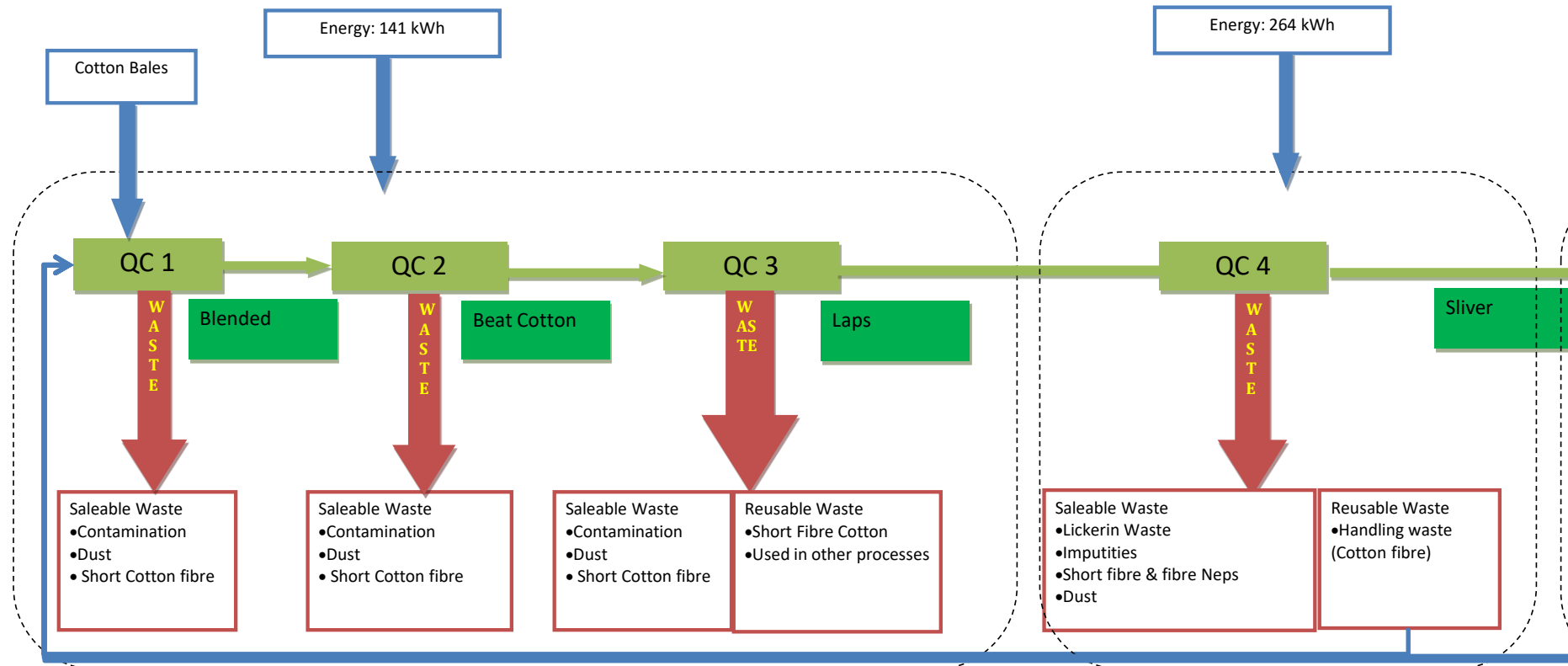

Yarn Production (aka Spinning)

Example Material Flow Chart

QC 1	Mixing, Plucking, Blending
QC 2	Multimix, Beating
QC 3	Sorting, Beating, Scutcher
QC 4	Carding
QC 5	Breaker Drawing
QC 6	Finisher Drawing
QC 7	Simplex
QC 8	Ring
QC 9	Auto Cone

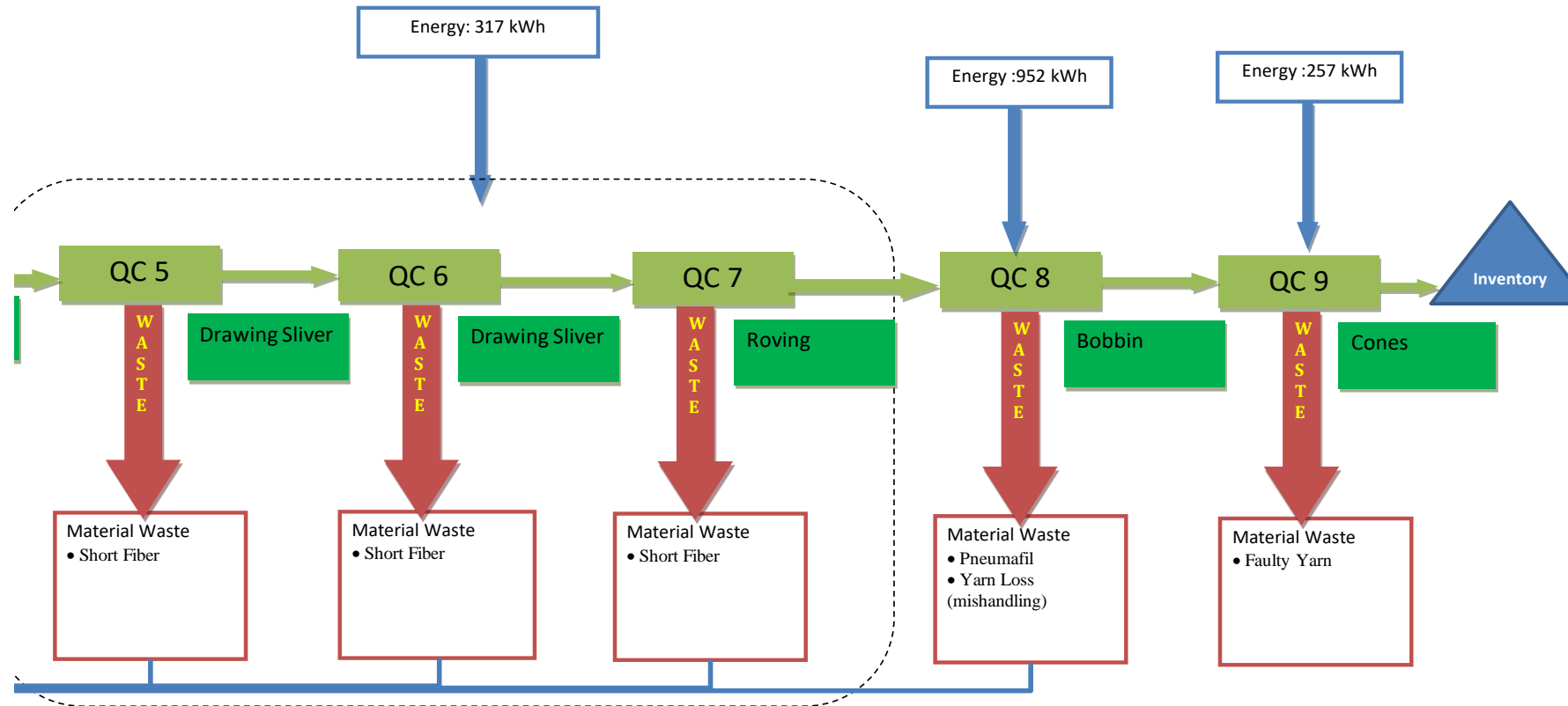

Source: Material Flow Cost Accounting of a Spinning Mill by Espire Consult

Material Flow Cost Accounting - Spinning

Example Material Flow Chart

QUANTITY DATA		Input	QC1	QC2	QC3	QC4	QC5	QC6	QC7	QC8	QC9	TOTAL
Material	kg	950	945.5	934.3	915.3	799.6	797.7	795.8	770.6	746.5	739.0	
Energy Input	kWh		141.0			264.0	317.0			952.0	257.0	1,931.0
System	Persons		42.0			37.0	57.0			60.0	38.0	234.0
Material Waste	Kg		4.5	11.2	4.2	79.1	1.1	1.1	15.0	2.8	7.5	126.6
Material Re-use	Kg				7.8	27.4	0.8	0.8	10.2	21.3		68.2
Dust	Kg				7.0	9.2						16.2
Total Material NPO	Kg		4.5	11.2	19.0	115.7	1.9	1.9	25.2	24.1	7.5	211.0
Energy NPO	kWh		29.6			55.4	66.6			199.9	54.0	405.5
System NPO	Persons		8.8			7.8	12.0			12.6	8.0	49.1

Source: Material Flow Cost Accounting of a Spinning Mill by Espire Consult

Material Flow Cost Accounting - Spinning

Example Material Flow Cost Accounting

COST DATA		Input	QC1	QC2	QC3	QC4	QC5	QC6	QC7	QC8	QC9	TOTAL
Material	PKR	166,250	167,848	165,859	162,486	141,955	141,616	141,277	136,796	132,519	131,337	
Energy Input	PKR		1,199			2,244	2,695			8,092	2,185	16,414
System	PKR		438			432	563			2,737	1,527	5,695
Material Waste	PKR		791	1,960	735	13,843	200	200	2,625	496	1,306	22,155
Material Re-use	PKR				1,365	4,795	135	134	1,792	3,721		11,942
Waste/dust Sold	PKR		(43)	(213)	(94)	(2,391)	(34)	(34)	(450)	(85)	(224)	(3,536)
Material NPO	PKR		748	1,747	2,006	16,246	300	300	3,967	4,132	1,082	30,529
Energy NPO	PKR		252			471	566			1,699	459	3,447
System NPO	PKR		92			91	118			575	321	1,196

Source: Material Flow Cost Accounting of a Spinning Mill by Espire Consult

Material Flow Cost Accounting - Spinning

Example Material Flow Cost Accounting

Cost		Material	Energy	System	Disposal	Total
Product	PKR	131,337	12,967	4,499		148,803
	%	79%	79%	79%		72%
NPOs	PKR	34,097	3,447	1,196	20,331	59,071
	%	21%	21%	21%	100%	28%

Source: Material Flow Cost Accounting of a Spinning Mill by Espire Consult

Spinning Energy Benchmarking - Pakistan

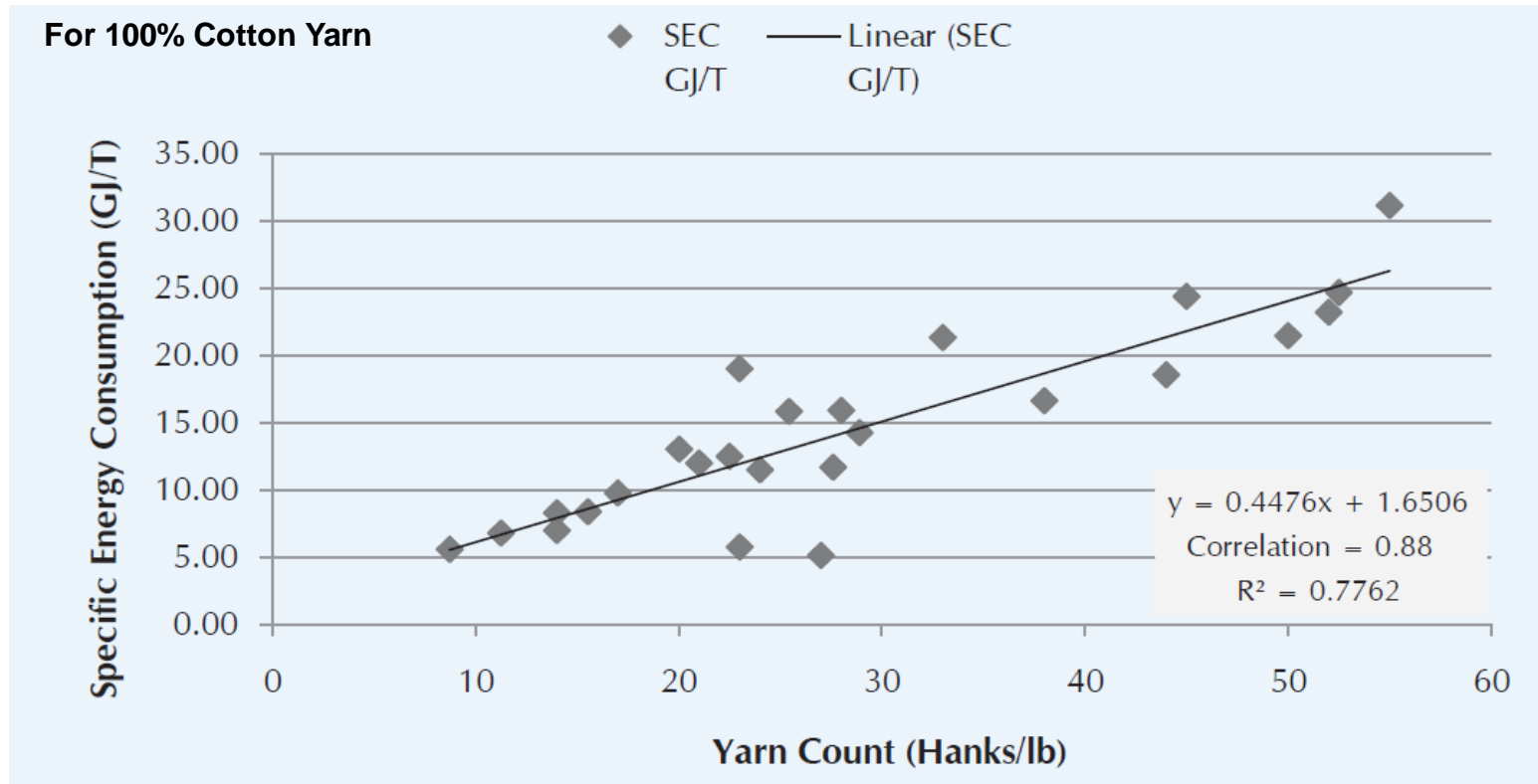

Source: UNIDO Sectoral Analysis on Renewable Energy and Energy Efficiency in Pakistan (2019)

Spinning Energy Consumption Ranges

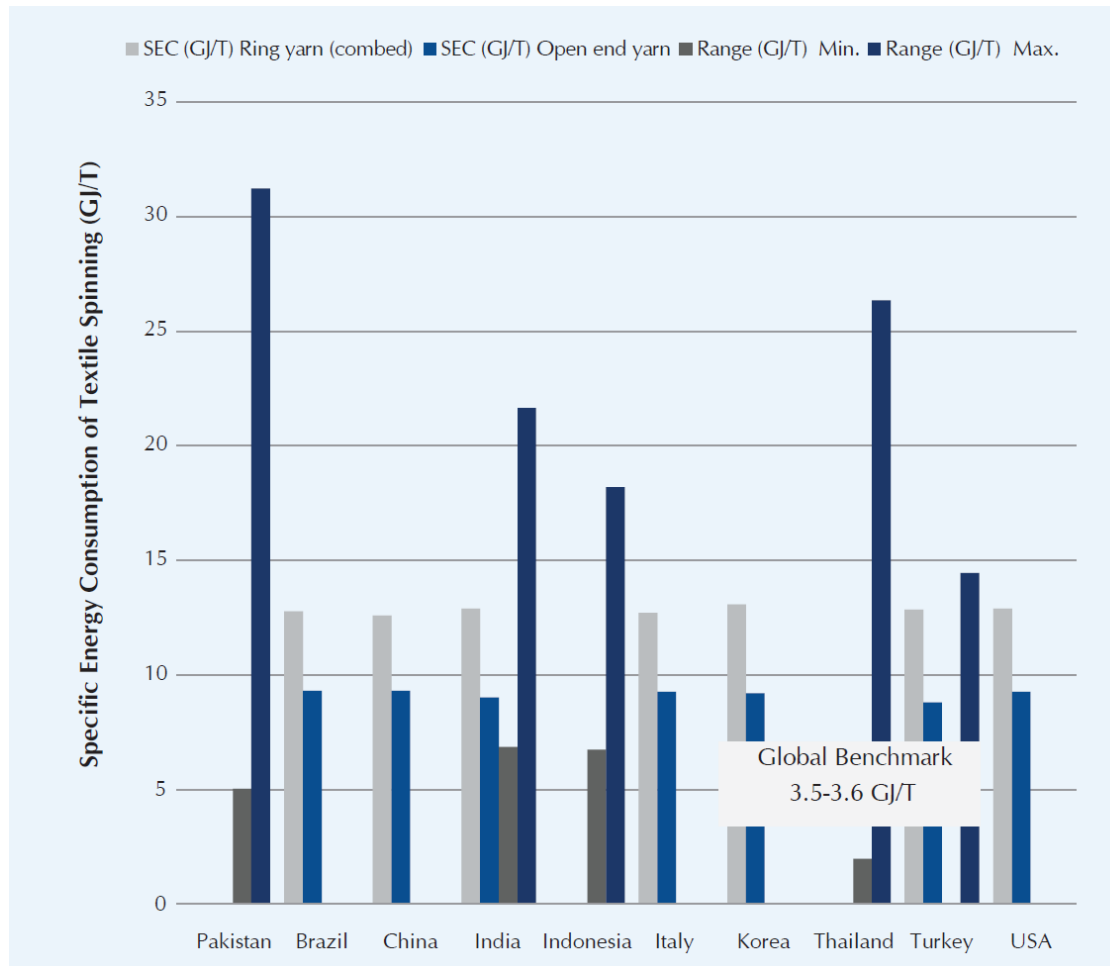

Source: UNIDO Sectoral Analysis on Renewable Energy and Energy Efficiency in Pakistan (2019)

Energy Balance of a Spinning Process

Example Energy Balance

- Main Energy type: Electrical Power
- Major utility: Compressed Air and Humidification Plant
- Largest consumer of energy : Ring Frames

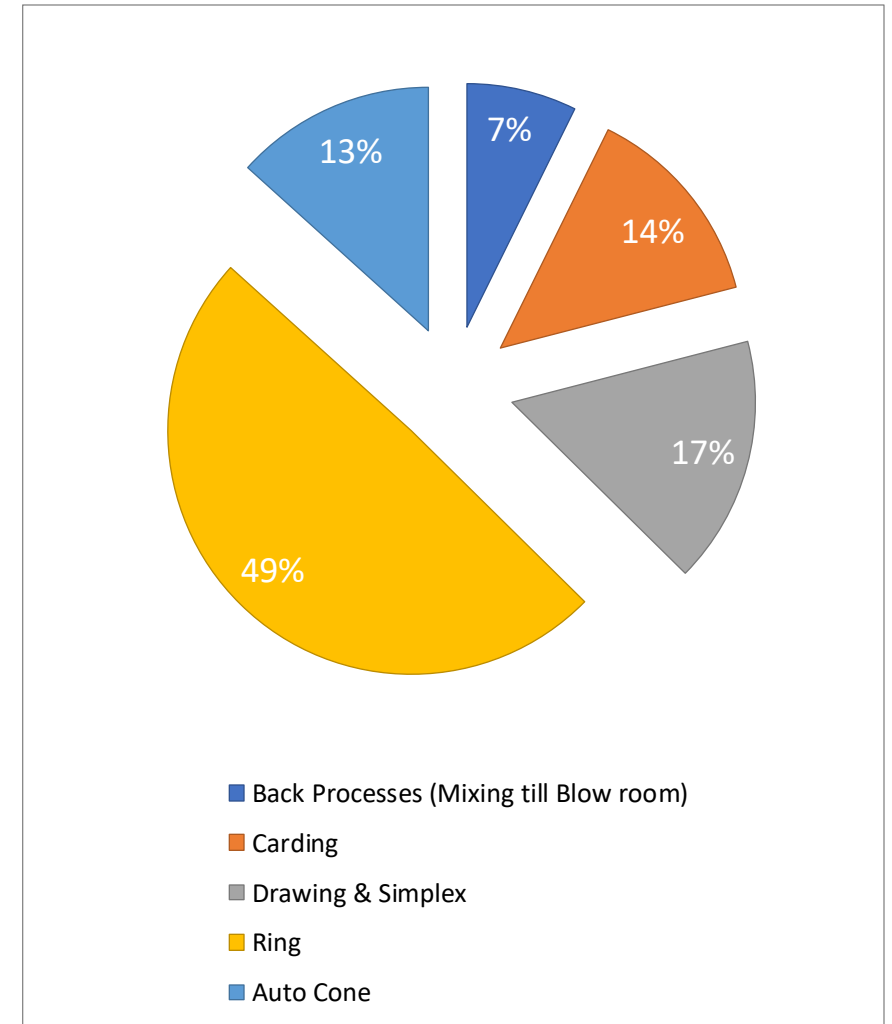

Source: Material Flow Cost Accounting of a Spinning Mill by Espire Consult

Yarn Production

Energy Performance Improvement Options

- Compressed air system
 - ✓ Demand side Pressure optimization
 - ✓ Leakage reduction
- Ventilation and Humidification Plant
 - 3-5% positive pressure between supply and exhaust air
 - Automated controls of humidification system
 - ✓ Optimization of Supply and Return Fans e.g. FRP Fans, Air Changes..
 - ✓ Optimization of Showering System e.g. Fogging System, Humidity feedback control...
- Machinery
 - ✓ Automation & synchronization of transportation fans in blow room
 - ✓ Avoiding fluff accommodation in machines to reduce friction and yarn breakages (especially Ring frames and Auto Cone)
 - ✓ Automation of machine speed according to yarn tension and loading in Ring frames

Textile Weaving



Weaving

Group work

- In your groups, develop typical energy flows and losses in Weaving process using the I.P.O. diagram.
- Present your results on flip chart in Information Market format

- Time 15 min

Weaving

- **Common Methods**

- Power Looms
- Water Jet Looms (mostly synthetic fibre)
- Air jet Looms
- Rapier Looms



Photo credit: M. Salman Butt, Espire Consult

- **Air Jet Loom Application**

Suitable for

- plain and textured fabrics
- fine high density fabrics
- High speed bulk production

- **Rapier Loom Application**

Suitable for

- multi-color weft fabrics
- yarn-dyed fabric
- double-layered velvet fabrics
- terry fabrics
- decorative fabrics
- Much slower than air jet loom
- Moderate energy consumption

Energy Balance – Example (Weaving)

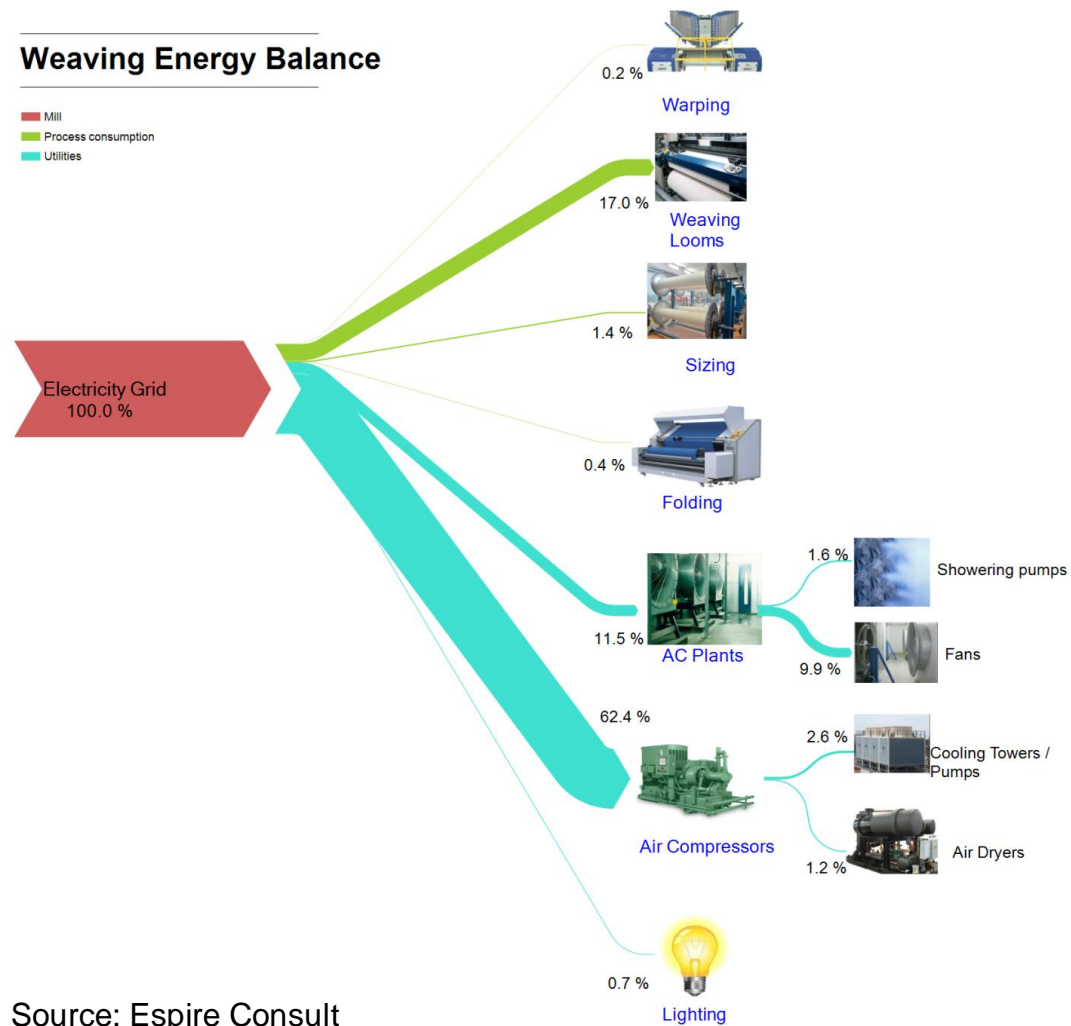

Source: Espire Consult

Weaving Energy Consumption Ranges

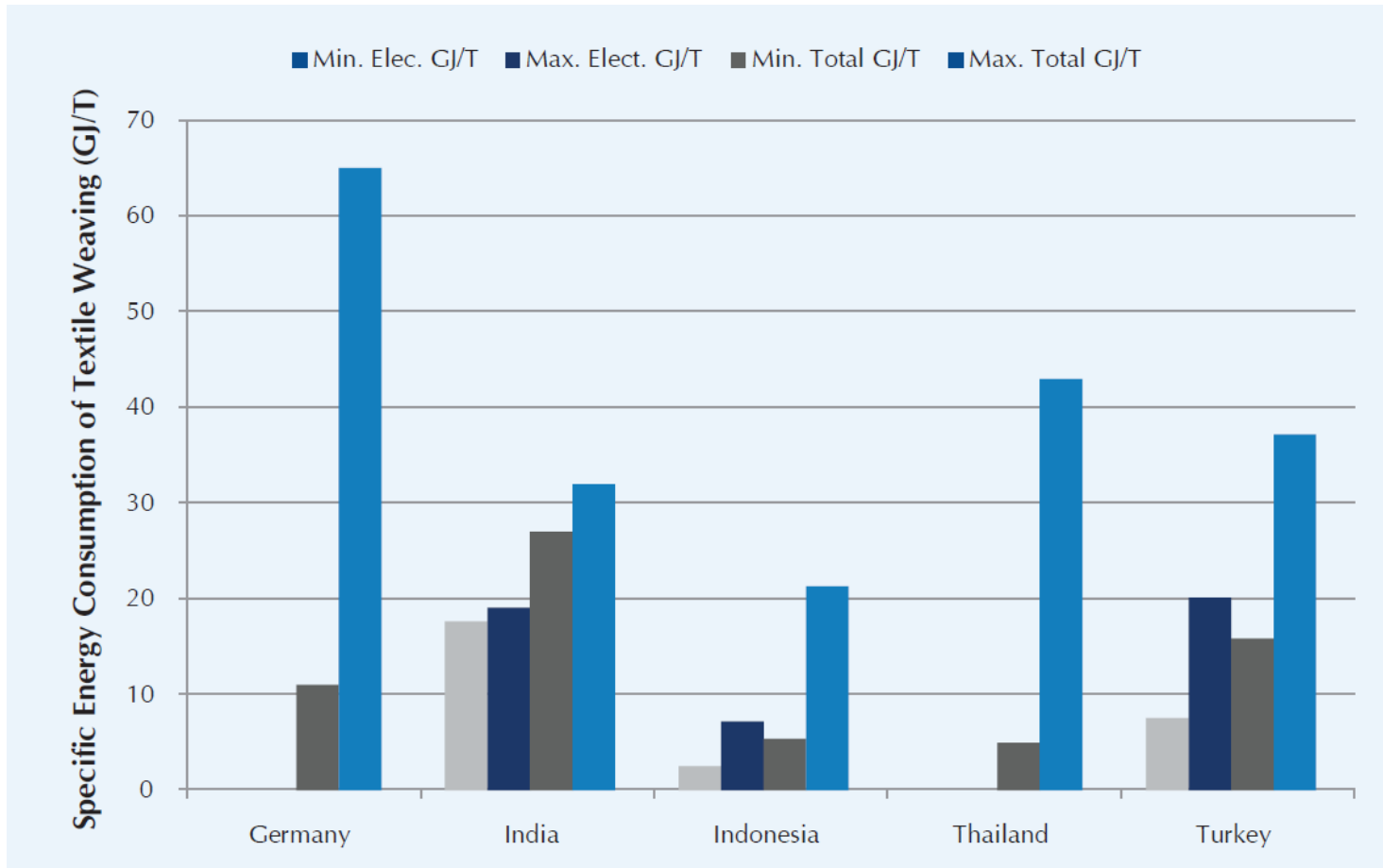

Source: UNIDO Sectoral Analysis on Renewable Energy and Energy Efficiency in Pakistan (2019)

Energy Efficiency Options in Air Jet Looms

- Control Air Leakages in looms
 - ✓ Leakages up to 15-20% of total air demand have been observed
- Optimize compressed air pressure according to yarn count
 - ✓ Mostly, higher air pressure is provided to cover for pressure loss due to leakages; hence inducing more leakages
- Automate the air conditioning parameters based on real-time temperature, and humidity
 - ✓ Don't forget to adjust air changes according to number of machines operating in the area; and temperature and humidity conditions
- Maintain Air Balance among Supply and Return air
 - ✓ Maintaining positive displacement (~3-5%) facilitates fluff removal from air, reducing fluff accumulation in the looms hence maintaining energy performance
- Production Planning
 - ✓ Improve machine up-time to improve energy performance

Common Air Leakages in Air Jet Looms

Relay Valve

Tuck Inn

Suction Mouth

Pre-winder

Internal PVC Link Pipes

Textile Wet processing



Fabric Wet Processing and Finishing

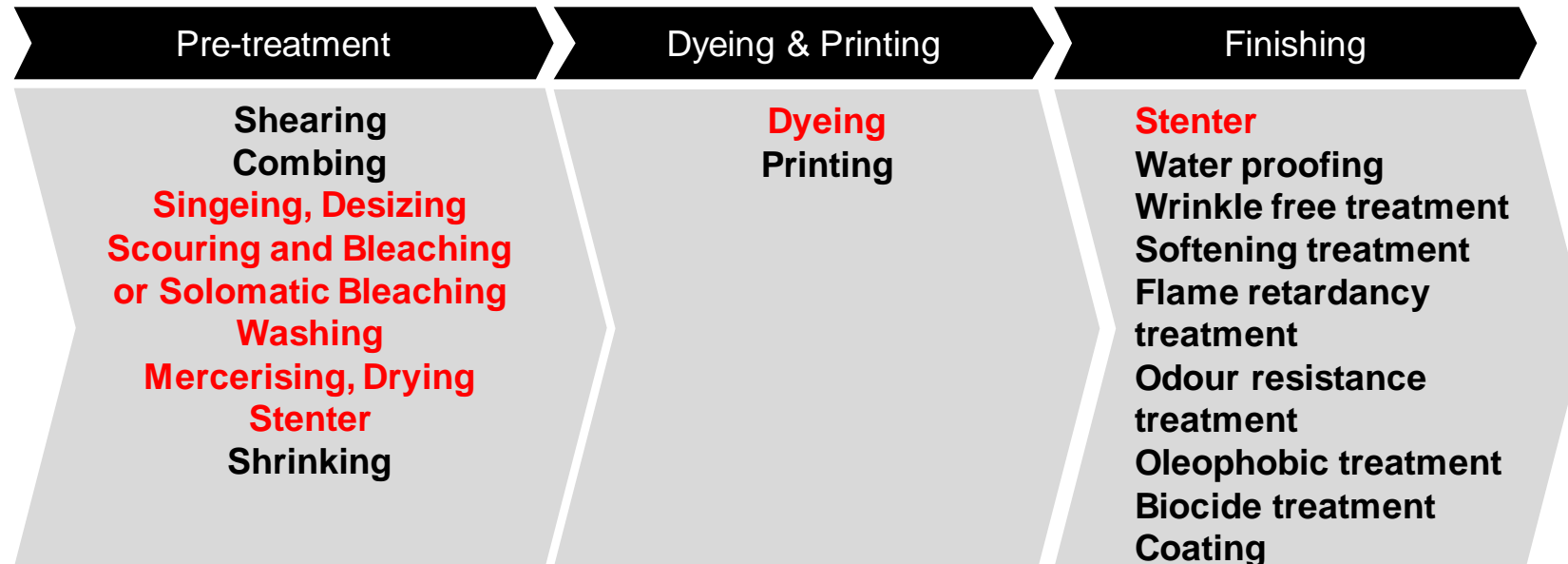

A-Fabric Pre-treatment (Open Width)

- Singeing-Desizing
- Batching
- Post Desizing Wash
- Scouring
- Bleaching
- Washing
- Drying
- Mercerizing (If cotton dyeing is required)

Singeing

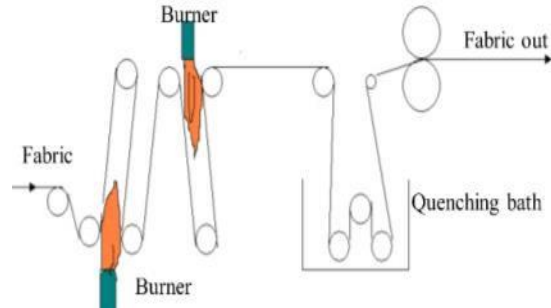

Methods

- Direct Flame application on fabric
- Passing fabric over a Heated Copper Plates/rollers

Energy Efficiency Options

- Controlling flame size and fabric roll speed
- Variable Flame Width
- Improve burner efficiency
- Recover and reuse cooling water

Parameter	O2	CO	NOx	NO	NO2	CO2	SO2	Flue Temp.
	%	ppm	ppm	ppm	ppm	%	ppm	°C
Standard (PEQs)		649	195				603	
New Singeing Machine	19.22	145	1.2	0	1.2	0.99	0	139

De-sizing



If Singeing is done, De-sizing is conducted in the Singeing Quenching batch

Methods vary according to size applied

- Enzymatic (Process control!; for starched based sizes)
- Oxidative (usually for different types of textiles, applying hydrogen peroxides, caustic soda) – Rarely used
- Use of acids (sulfuric or hydrochloric acid)
- Washing out with hot water and wash soda

Energy Efficiency Options

- Waste water heat recovery
- Improving Insulation of Hot Water Baths
- Optimizing process using pH, temperature and speed with automation

Bleaching



Common methods

- Hydrogen peroxide (H_2O_2)
- Sodium hypochlorite (chlorine bleaching lye, $NaClO$)
- Sodium chlorite ($NaClO_2$)
- Sulphur dioxide (SO_2)

Energy Efficiency Options:

- Waste water heat recovery (~6m payback)
- Improved heat exchanger material (e.g. Stainless Steel) allowing longer life and reduced corrosion; hence improving heat exchanger efficiency

Mercerising

Refining process with the aim of improving tensile strength, dimensional stability and improved absorbency for consequent dyeing

Methods

- Sodium hydroxide bath with heat treatment under tension or without tension, then neutralization with an acid plus washing
- Ammonia (very rare)

Energy Efficiency Options

- Optimizing steam in-take of Drying Rollers
 - vendors claim ~14% steam saving but its not verifiable; companies have experienced improvement in process quality and control
- Waste water heat recovery
- Caustic Recovery (shown on next slide)
- Reusing Mercerising wastewater in scouring

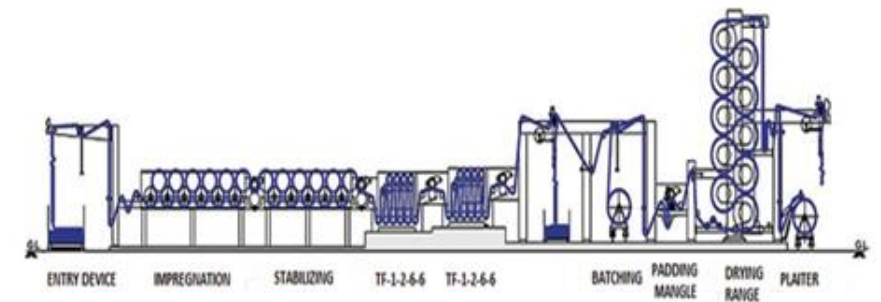
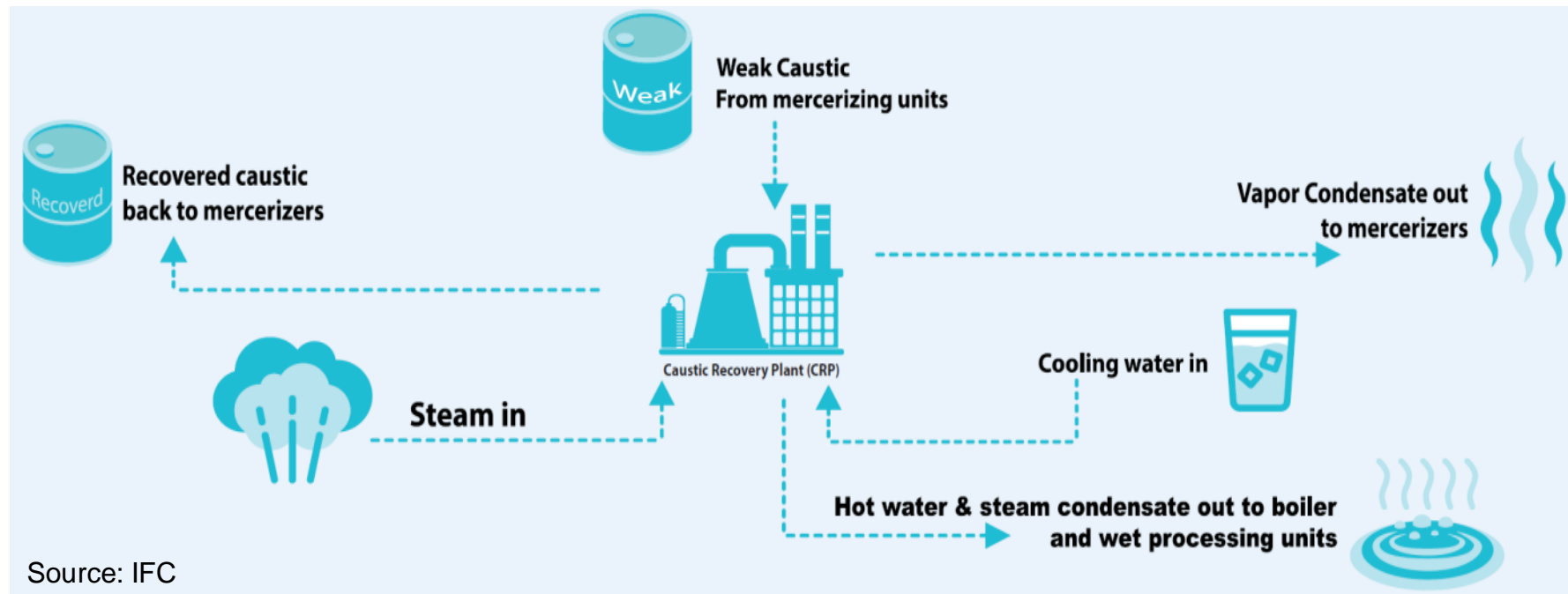

Photo Source: textiletoday.com.bd

Recovering NPOs – Caustic Recovery Plant

- NaOH is re-used in Mercerising (24 – 30 Baume)
- H₂SO₄ consumption is reduced at Effluent Treatment
- Hot water available to feed into the processes – saving steam
- Return on Investment ~ 3 years



B- Dyeing

Group work

- In your groups, develop typical energy flows and losses in Dyeing process using the I.P.O. diagram.
- Present your results on flip chart in Information Market format
- Time 15 min

Dyeing approaches

- **Material dyed**
 - Twine
 - Yarn
 - Knitted / woven fabric
 - Garment
- **Process**
 - Batch
 - Continuous
- **Dyeing techniques**
 - Gel dyeing (in the production of artificial fibres)
 - Pigment dyeing (with binder)
 - Diffusion dyeing
 - Exhaust dyeing
 - Ozone dyeing
 - ✓ Ozone can be used on indigo or black sulfur fabrics.
 - ✓ Use of ozone requires up-front investment in the ozone machine and the generators, along with safety training for workers.

Fabric Dyeing

- **Cellulosic Fabric Dyeing (Cotton, Viscose, Lyocell, linen, hemp etc.)**
 - ✓ Reactive Dyes
 - ✓ Temperature Required around 65 deg C for which machines work at atmospheric pressure
- **Synthetic Fabric / Blended (Polyester, PC, Nylon etc.)**
 - ✓ Disperse Dyes
 - ✓ Temperature Required Above 100 deg C for which machines work above atmospheric pressure

Fabric Dyeing

- **Batch/Discontinuous**
 - ✓ Open Width form Dyeing
 - Open Jiggers and Pressure Jiggers, Beam,
 - ✓ Rope form Dyeing
 - Jets, Winches, Soft flow machines / HT machines (Knitted fabric)
- **Semi Continuous**
 - ✓ Pad Batch / Cold Pad Batch (CPB)
 - (For Cellulosic Materials and alternative to reactive dyeing)
 - ✓ Pad Jig
 - ✓ Pad Roll
- **Continuous**
 - ✓ Chemical Steam Pad
 - ✓ Pad Dry Steam (PDS)
 - ✓ Pad Dry Pad Steam (PDPS)
 - ✓ Pad Dry Cure (PDC)
 - ✓ Pad Thermosol Dyeing

Dyeing – Basic steps

Step 1

- Colouring agents (mostly powder form, dye) dissolved in "dye liquor" according to a given recipe
- Dyestuffs diffuse from "liquor" to the substrate

Step 2

- Dyestuff accumulates on the surface of the yarn/fabric => question of the affinity of the dyestuff to the fibre

Step 3

- Penetration of the fibre with the dye (slower than surface accumulation) => prerequisite given for hydrophilic fibres (micropores); in the case of **hydrophobic fibres => heating necessary (often over 100 degrees)**
- Addition of salts to overcome electrostatic surface barriers

Step 4

- Fixation of dyestuffs (**heat**, auxiliaries)

Benchmarks to look out for in dyeing

Liquor ratio

- Dye bath = solvent (usually water) as well as all dissolved, emulsified or dispersed components contained therein such as dyes, pigments, chemicals and auxiliaries.
- Liquor ratio (LR) = Ratio of quantity of fabrics to dyebath liquor (kg to kg or kg to liters)
- Mostly referred to in batch-dyeing
- Aim => To achieve low liquor ratios

For example: 200 kg fabrics, 1400 ltr dyebath
=> LR 1:7

Fixation rate

- Percentage of dye used that remains on the material to be dyed.
- Different extraction rates depending on dye and process

Batch Dyeing

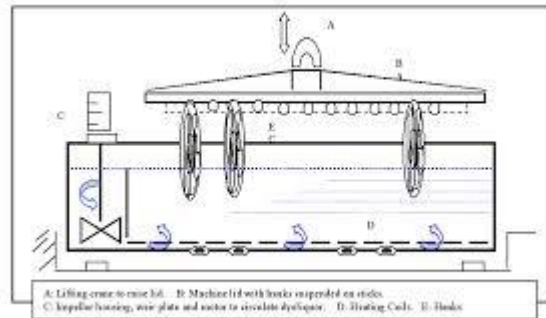

Hank dyeing, LR
1:12 – 1:25

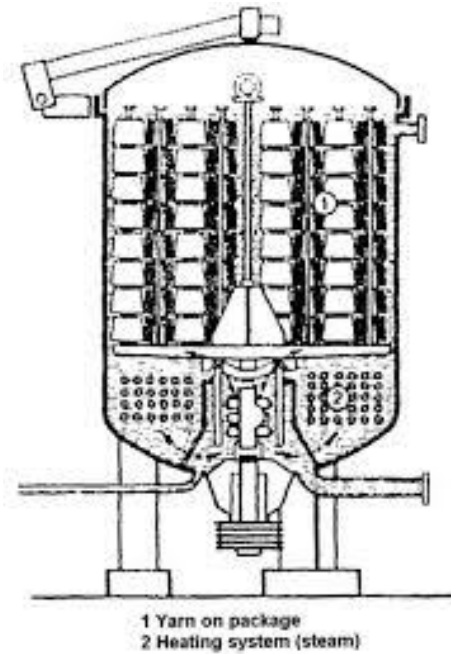

bobbin dyeing 1:8 – 1:15



Package Dyeing – Knitware



Jig Dyeing
LR 1:3 – 1:6

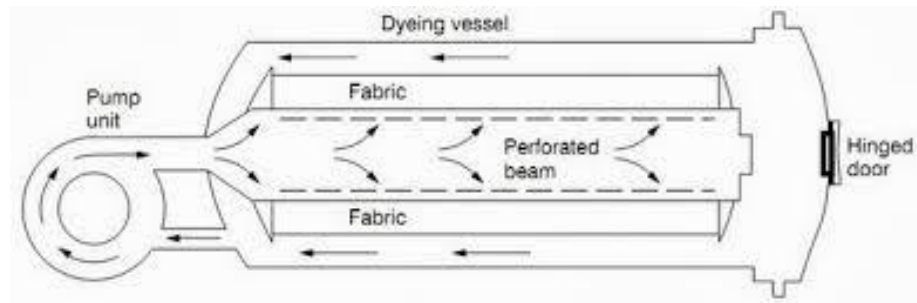

Beam dyeing)
LR 1:8 - 1:10

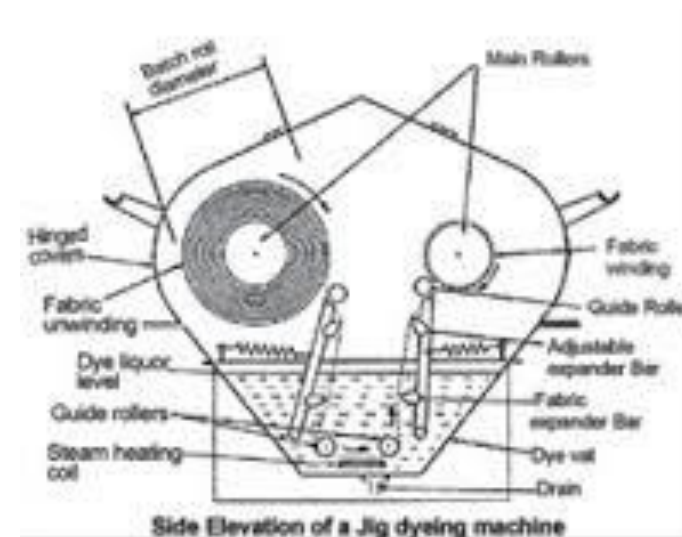

„Winch“ dyeing

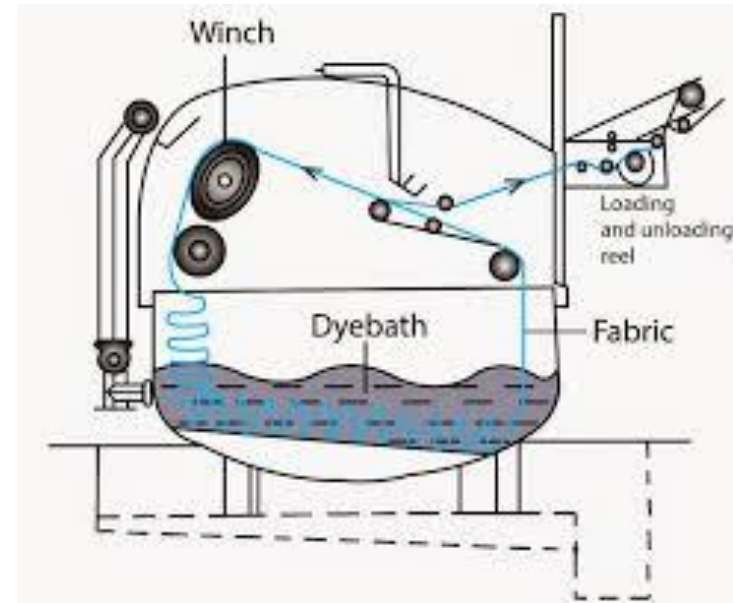

LR 1:15 - 1:40

„Jet“ Dyeing machines

Also called SoftFlow Machines



LR 1:4 - 1:10

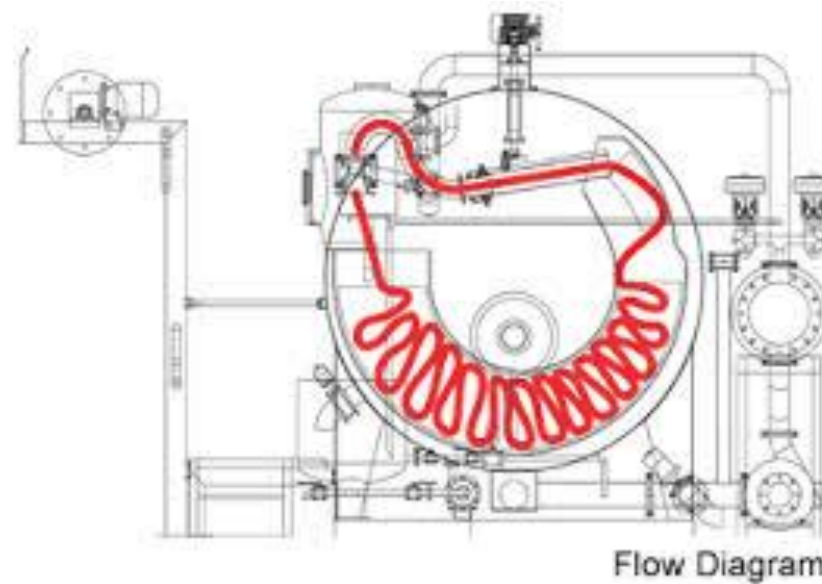

Feed-through dyeing machines

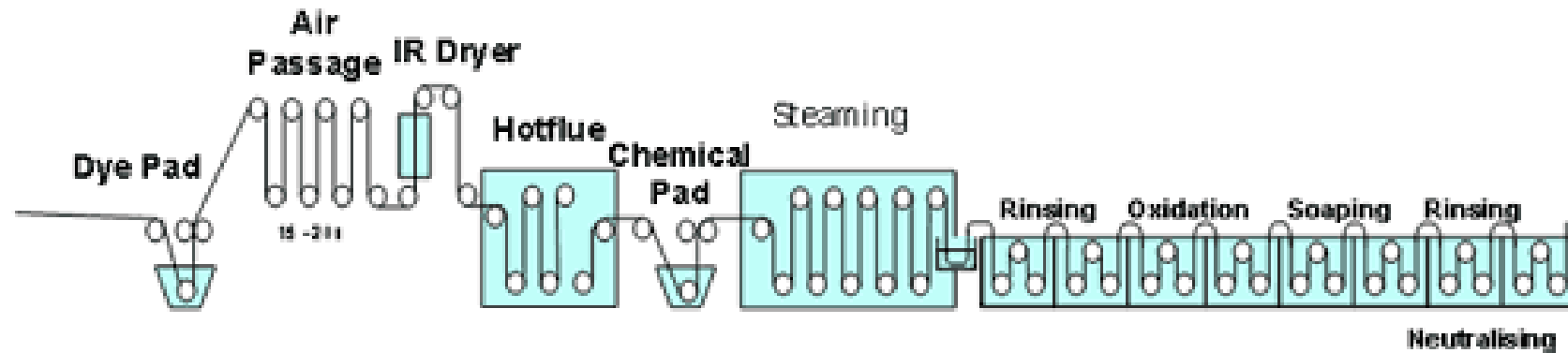

Energy Efficiency Options in Dyeing

- Using low TDS water for dyeing and post dyeing operations helps reducing
 - ✓ Dyes, chemicals and auxiliary consumption
 - ✓ Process time
 - ✓ Liquor Ratio
- Improved heat exchanger material (e.g. Stainless Steel) allowing longer life and reduced corrosion; hence improving heat exchanger efficiency
- Low Liquor Ratio and use of high fixation dyes helps reducing
 - ✓ Steam consumption
 - ✓ Water pumping cost
 - ✓ Process time → electrical energy
- Improve insulation of machine
- Wastewater heat recovery
 - ✓ Additionally, an insulated hot water storage tank might also be needed if hot water is to be used in process
- Cooling water recovery and reuse

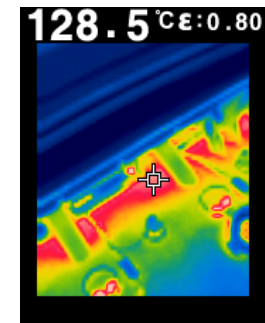

Switching to Cold Pad Batch (CPB) instead of conventional reactive dyeing

- It is not possible to switch to cold pad batch dyeing for every reactive dyeing setup (High precision and control required)
- However, the associated benefits encourage the textile mills to put in more efforts
 - ✓ Up to 50% energy consumption reduction
 - ✓ Up to 50% water consumption reduction and reduced wastewater
 - ✓ No use of salt, reducing the pollution load of generated wastewater
 - ✓ The fabric don't undergo abrasion so dyed fabrics have smoother surface

Question

What are the Energy benefits of reducing liquor ratio and improving fixation in dyeing?

C- Printing

Group work

- In your groups, develop typical energy flows and losses in Printing process using the I.P.O. diagram.
- Present your results on flip chart in Information Market format
- Time 15 min

Fabric Printing

- In industry 03 types of machines are used for printing the fabric
 - Rotary Printing
 - Flat bed / Panel Printing
 - Digital Printing

Fabric Printing

- **Normally fabric is printed through two methods**
 - ✓ Pigment Printing: Surface Printing where design is fixed with the help of binders and fixers. **Curing is done through dry heat** in curing chambers above **100 °C** (depending upon the colour recipe)
 - ✓ Reactive Printing: The colour design is attached to fabric as a result of chemical reaction. **Curing is done in a high temperature** (close to **100 °C**) moist environment. This type of fabric requires washing after printing.

Energy Efficiency Options in Printing

- **The Curing chamber is the main area of interest in which air is heated either through direct natural gas firing or indirect air hot thermal oil**
 - ✓ Automation of curing chambers through linking fans and fuel firing with exhaust moisture and temperature of each chamber
 - ✓ Heat Recovery from exhaust flue gases
 - ✓ Insulation of curing chambers

- **In Textiles two types of Finishing Processes are used**
 - ✓ Chemical Finishing in Stenter Machines: Either direct firing of natural gas or indirect heating through Thermal Oil
 - ✓ Mechanical Finishing: Mostly steam is used for indirect heating at following machines
 - Calendars
 - Comfort
 - Sanforizer

- **In Textiles two types of Finishing Processes are used**
 - ✓ Chemical Finishing in Stenter Machines: Either direct firing of natural gas or indirect heating through Thermal Oil
 - ✓ Mechanical Finishing: Mostly steam is used for indirect heating at following machines
 - Calendars
 - Comfort
 - Sanforizer

Stenter

Group work

- In your groups, develop typical energy flows and losses in a Stenter using the I.P.O. diagram.
- Present your results on flip chart in Information Market format
- Time 15 min

Energy Efficiency Options:

- Modulation of Thermal Oil Heater/ Gas Burners according to temperature requirement in Stenter
 - oil temperature of +50C is required)
- Automation of stenter exhaust according to required temperature, **moisture** and feed rate of fabric
 - requires installing VFD on ID/FD Fan, and fabric moisture sensors
 - Other Benefit: Results in improved quality by reducing shade variation
- Exhaust air waste heat recovery system
 - Requires an efficient filter before the waste heat recovery system
 - CAUTION: install proper control systems to avoid fire in the filter



Photo Source: Sekkeli, Mustafa & Kececioglu, Fatih. (2012). SCADA based an energy saving approach to operation of stenter machine in a textile plant using waste heat recovery system. *Tekstil ve Konfeksiyon*. 03. 248-257.

Example Calculations

Parameters	Unit	Values
Calculation for 1 stenter		
Exhaust Air flow	kg/s	2.45
Stenter exhaust temperature T1	°C	160
Target exhaust temperature T2	°C	100
Temperature Reduction dT	°C	60
Operational hours	Hours/year	7,200
Specific Heat of Air	kJ/kg-C	1
Available energy	kJ/h	[Redacted]
Recoverable energy (@70% efficiency)	GJ/y	
Coal saving per stenter	Tonne/y	
Financial Saving per stenter	USD/y	
Investment per stenter	USD	
Payback period	months	
GHG emission reduction per stenter	TonneCO2/y	

Calorific Value of Coal	23.36	GJ/tonne
Emission factor of Coal	0.089	tCO2/GJ
Coal price	0.125	USD/kg

Example Calculations

Parameters	Unit	Values
Calculation for 1 stenter		
Exhaust Air flow	kg/s	2.45
Stenter exhaust temperature T1	°C	160
Target exhaust temperature T2	°C	100
Temperature Reduction dT	°C	60
Operational hours	Hours/year	7,200
Specific Heat of Air	kJ/kg-C	1
Available energy	kJ/h	529,200
Recoverable energy (@70% efficiency)	GJ/y	2,667
Coal saving per stenter	Tonne/y	143
Financial Saving per stenter	USD/y	17,838
Investment per stenter	USD	25,000
Payback period	months	17
GHG emission reduction per stenter	TonneCO2/y	298

Calorific Value of Coal	23.36	GJ/tonne
Emission factor of Coal	0.089	tCO2/GJ
Coal price	0.125	USD/kg

Garment Making

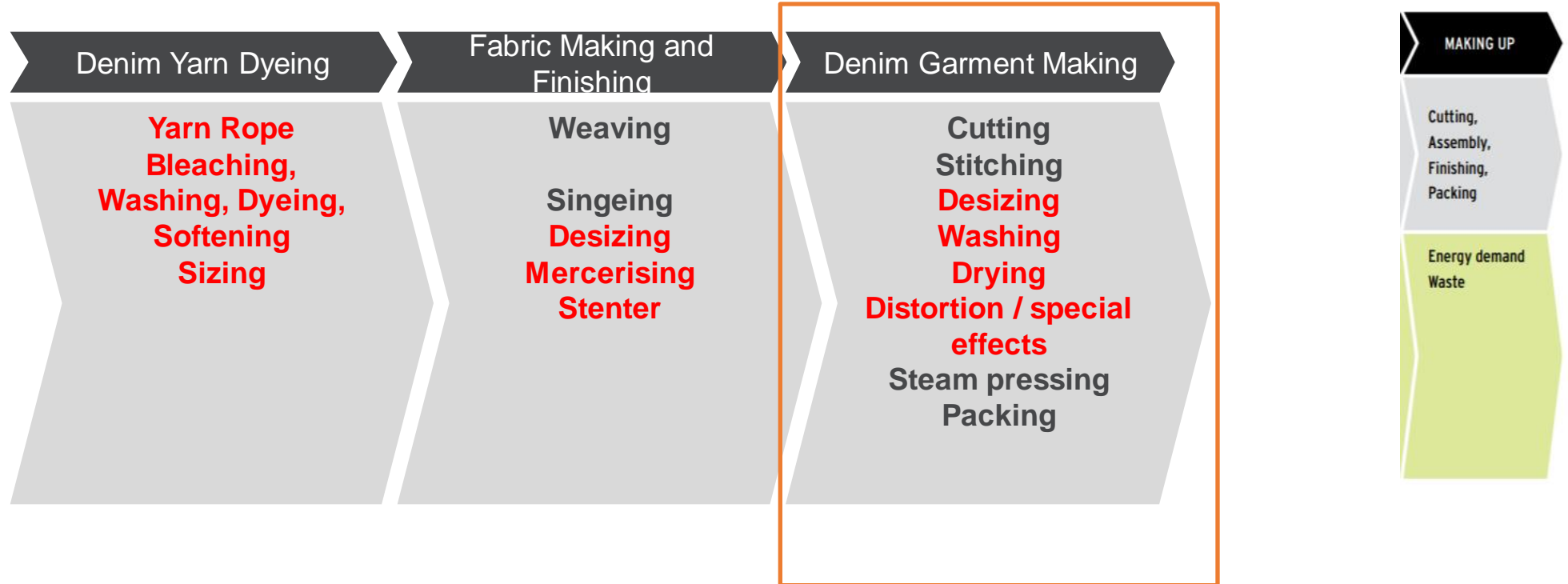

Cut to Pack (Garments)

- This segment shapes up the final product ready for dispatch. It includes following areas;
 - ✓ Pattern Making
 - ✓ Cutting
 - ✓ Stitching
 - ✓ Packing
- Cut to Pack Units are human resource intensive so utilities like lighting, ventilation, thermal comfort, drinking water etc. are required to maintained and can be inspected accordingly.

Stitching Process Optimization

- Installing Servo Motors brings return on investment typically within One year
- Additionally, 8-10% variation in process times is usually observed; possible savings include:
 - ✓ Electricity
 - ✓ Compressed air
 - ✓ Process time, resulting in higher productivity

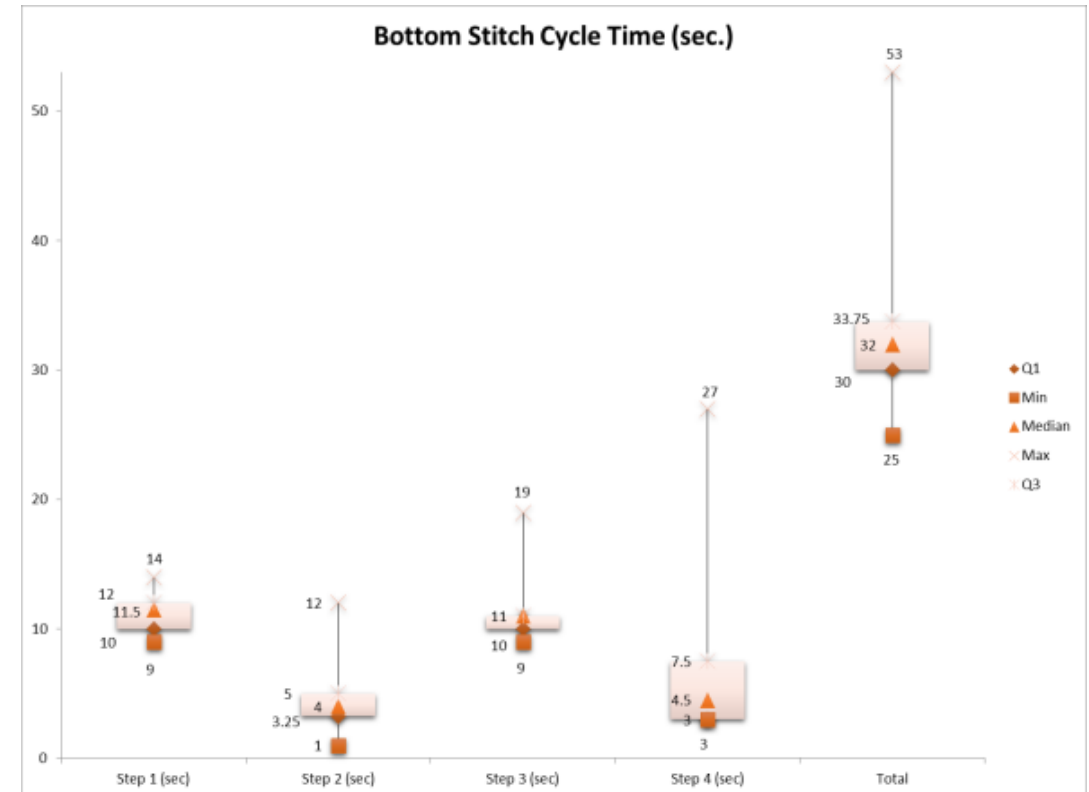

Source: Box plot of a stitching process by Espire Consult

Stitching Process Optimization

- Installing Servo Motors brings return on investment typically within two year
- On-load time is 60% of the Cycle Time (normally this value is lower which would increase saving potential)
- Calculate annual energy saving (assume annual operation 7200 hrs)

Motor Type	Loading	Load (kW)
Clutch Motor	On-load	0.638
	Off-load	0.2332
Servo Motor	On-load	0.528
	Off-load	0.0242
Sample measurements of stitching machine power consumption		

Energy Saving = On-load 475 kWh + offload 602 kWh = Total 1,077 kWh

Garment Washing

Group work

- In your groups, develop typical energy flows and losses in Garment Washing process using the I.P.O. diagram.
- Present your results on flip chart in Information Market format
- Time 15 min

Denim Garment Washing

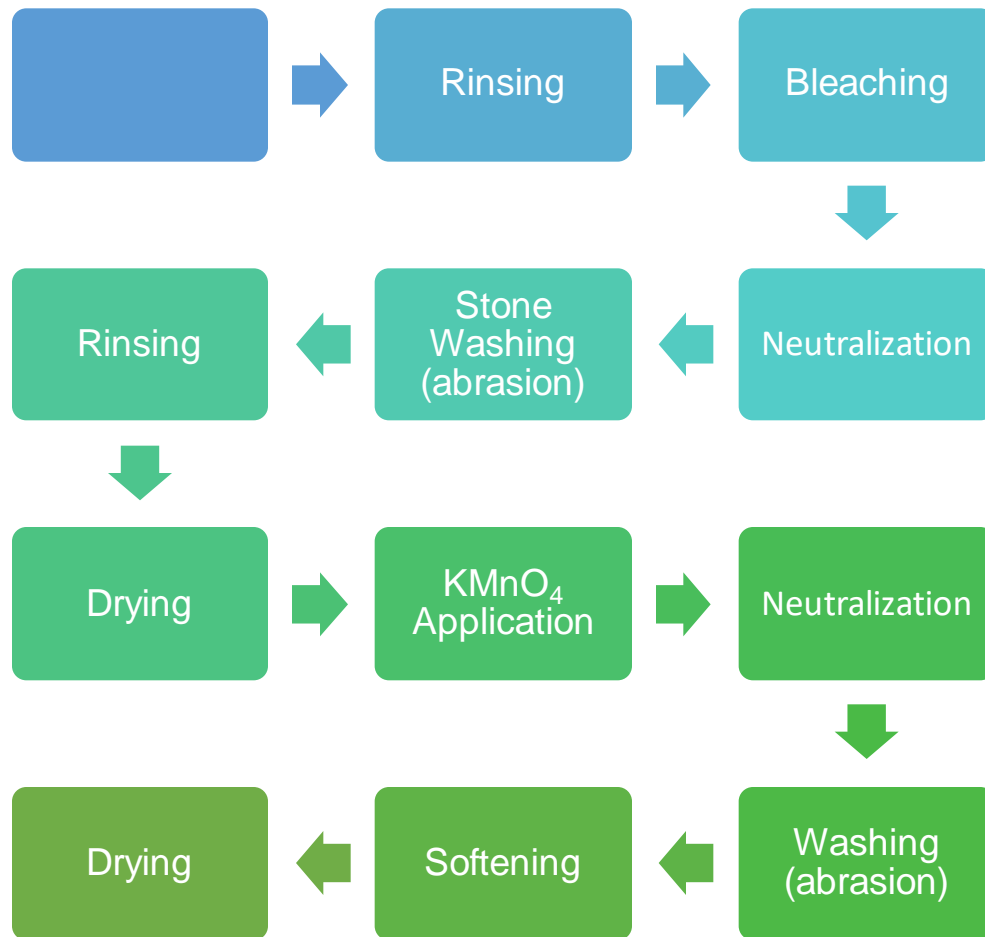

Denim Production – Washing

Mechanical processes

- Rinse wash
- Water jet fading
- Stone wash
- Whiskering
- Microsanding including sandblasting
- Mechanical abrasion
- Laser treatment

Chemical processes

- Acid wash, ice or snow wash
- Hydrogen peroxide wash or bleach washing
- Enzyme wash
- Ozone fading
- Spray techniques
- Overdyeing and tinting

Levi Strauss & Co. Water<Less™ Program

Low Liquor Ratio in Stone Wash

- Water savings counted: ½ Stone Wash bath
- Average water savings: 2.4 liters / jean
- Energy Saving: Steam used for ½ Stone Wash bath
- Frequency of use: Moderate
- Critical issues
 - ✓ Back staining may occur if this technique is not properly applied.
 - ✓ Low liquor ratio stonewash can be difficult in a belly washer machine.
 - ✓ It is not recommended to use a liquor ratio below 3:1.
 - ✓ Advances in enzyme and dispersant chemistry make this technique possible

Levi Strauss & Co. Water<Less™ Program

Combine desize and stonewash / enzyme wash

- Water savings counted: Two total baths, a de-size and a rinse
- Average water savings: 11.8 liters / jean
- Energy Saving: Electricity and Steam used for 2 baths
- Frequency of use: High
- Method
 - ✓ When a stonewash or enzyme wash follows a desize bath in a finish formula, it traditionally requires four baths: a desize bath, a rinse, a stonewash or enzyme bath, and another rinse. Combining the desize step with the stonewash/enzyme wash followed by a rinse reduces the process to a total of two baths.
- Critical Issues
 - ✓ Not recommended for fabrics that bleeds a lot.
 - ✓ An extra dispersant in the bath may be required to avoid back staining.

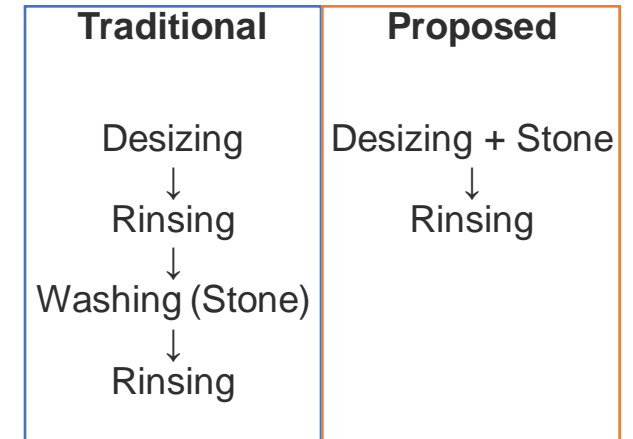

Levi Strauss & Co. Water<Less™ Program

Remove de-size step

- Water savings counted: One de-size bath
- Average water savings: 5.9 liters / jean
- Energy Saving: Electricity and Steam used for One de-size and One Rinsing bath
- Frequency of use: High
- Critical issues
 - ✓ Possible if Water Soluble Sizing material is used in Denim Mill – needs encouragement from the Brands / Buyers
 - ✓ In the case of a heavy weight fabric or a fabric that is sensitive to abrasion, a rinse step might still be necessary
 - ✓ Challenges with shrinkage may arise

Levi Strauss & Co. Water<Less™ Program

Increasing Ozone Concentration

- Water savings counted: A bleach bath and a generic neutralization bath
- Average water savings: 12 liters / jean
- Energy Saving: Electricity and Steam used for One bleach and One Neutralization bath
- Frequency of use: Moderate
- Method
 - ✓ Higher concentrations of ozone achieve more pronounced lightening effects, effectively replacing many uses for wet bleach baths.
 - ✓ Lightening a garment with a wet bleaching agent typically requires three wet baths: a bleach bath, a neutralize bath, and a rinse bath. If ozone use comes in the middle of a finish formula, it saves all three baths.
 - ✓ If ozone use is the first step in a formula, it only saves two baths because the garments need to be wet before being loaded into the machine.
- Critical Issues
 - ✓ Ozone can be used on indigo or black sulfur fabrics only.
 - ✓ Use of ozone requires up-front investment in the ozone machine and the generators, along with safety training for workers

Levi Strauss & Co. Water<Less™ Program

Spray potassium permanganate on raw garments

- Water savings counted: One neutralization bath
- Average water savings: 5.8 liters / jean
- Energy Saving: Electricity and Steam used for One Neutralization bath and One Drying Cycle
- Frequency of use: High
- Method
 - ✓ Applying the spray at the beginning of the finish formula – before the garments ever get wet – allows the neutralization agent to be added to the first existing wet bath.
 - ✓ The neutralization bath is removed, and the rinse that follows neutralization is also **potentially** removed.
- Critical Issues
 - ✓ This technique works best with dark finishes
 - ✓ Be aware of potential back staining

Drying Process

- Modulate steam pressure according to process temperature requirement i.e. Shade, fabric weight, batch size etc. to optimise steam use
- Majority companies don't even install Steam Pressure Reducing Valves with dryers and all dryers are provided same pressure
- Assess possibility of recirculating the machine exhaust air
- This would require installing a fluff collector Jute bag (like used in Carding Machine filters in Spinning industry) and adding 30~40% fresh air
- May result in better heat exchange as well as reduction in process time and Steam consumption



Water Saving Duplication Rules

	Prohibited: Savings cannot be combined if both techniques appear in the same formula
	Okay: Savings can be combined

Techniques	Remove desize step	Ozone*	Foam dye/tinting	Foam bleach	Spray softener	Low liquor ratio for stonewash	Sky Bleach / Rags Bleach/ Acid Wash/ Moonwash	Soft rigid	Combine desize, enzyme wash & bleach	Combine desize & stonewash/ enzyme wash	Combine resin & tint steps & apply by dipping	Spray potassium PP on raw garments	Neutralize the bleach in the same desize	Low liquor ratio for desize	High fixation reactive dye	Combine fixing & softener	Ozone mist*	Combine enzyme & softener	Low liquor ratio bleach	Low liquor ratio reactive garment	Enzyme spray stonewash
Remove desize step	Grey	Green	Green	Green	Green	Green	Green	Green	Red	Red	Green	Green	Green	Red	Green	Green	Green	Green	Green	Green	Green
Ozone*	Grey	Grey	Green	Red	Green	Green	Red	Green	Green	Green	Green	Green	Red	Green	Green	Green	Red	Green	Red	Green	Green
Foam dye/tinting	Grey	Grey	Grey	Green	Green	Green	Green	Green	Green	Green	Red	Green	Green	Green	Red	Green	Green	Green	Green	Red	Green
Foam bleach	Grey	Grey	Grey	Grey	Green	Green	Red	Green	Green	Green	Green	Green	Red	Green	Green	Green	Red	Green	Red	Green	Green
Spray softener	Grey	Grey	Grey	Grey	Grey	Green	Green	Red	Green	Green	Green	Green	Green	Green	Green	Red	Green	Red	Green	Green	Green
Low liquor ratio for stonewash	Grey	Grey	Grey	Grey	Grey	Grey	Green	Green	Green	Green	Green	Green	Green	Green	Green	Green	Green	Green	Green	Green	Red
Sky Bleach / Rags Bleach/ Acid Wash/ Moonwash	Grey	Grey	Grey	Grey	Grey	Grey	Grey	Green	Green	Green	Green	Green	Red	Green	Green	Green	Red	Green	Red	Green	Green
Soft rigid	Grey	Grey	Grey	Grey	Grey	Grey	Grey	Grey	Red	Green	Green	Green	Green	Green	Green	Red	Green	Red	Green	Green	Green
Combining desize, enzyme wash & bleach	Grey	Grey	Grey	Grey	Grey	Grey	Grey	Grey	Red	Green	Green	Green	Red	Green	Green	Green	Red	Green	Red	Green	Green
Combining desize & stonewash/enzyme wash	Grey	Grey	Grey	Grey	Grey	Grey	Grey	Grey	Red	Green	Green	Green	Red	Green	Green	Green	Green	Red	Green	Green	Red
Combine resin & tint steps & apply by dipping	Grey	Grey	Grey	Grey	Grey	Grey	Grey	Grey	Green	Green	Grey	Green	Green	Green	Red	Green	Green	Green	Green	Red	Green

Water Saving Duplication Rules

	Prohibited: Savings cannot be combined if both techniques appear in the same formula
	Okay: Savings can be combined

Techniques	Remove desize step	Ozone*	Foam dye/tinting	Foam bleach	Spray softener	Low liquor ratio for stonewash	Sky Bleach / Rags Bleach/ Acid Wash/ Soft rigid	Combine desize, enzyme wash &	Combine desize & stonewash/ enzyme	Combine resin & tint steps & apply by	Spray potassium PP on raw garments	Neutralize the bleach in the same	Low liquor ratio for desize	High fixation reactive dye	Combine fixing & softener	Ozone mist*	Combine enzyme & softener	Low liquor ratio bleach	Low liquor ratio reactive garment	Enzyme spray stonewash
Spray PP on raw garments																				
Neutralize the bleach in the same bath																				
Low liquor ratio for desize																				
High fixation reactive dye																				
Combine fixing & softener																				
Ozone mist																				
Combine enzyme & softener																				
Low liquor ratio bleach																				
Low liquor ratio reactive garment dye																				
Enzyme spray stonewash																				

Blow Cleaning in Distortion

- Install high pressure electric blower with custom nozzle instead of using compressed air
- Reference calculations
 - ✓ 03 pipes of 4mm internal diameter at each workstation
 - ✓ Air consumption = 94 m³/h per workstation
 - ✓ Cost saving per work-station = ~6,000 USD/y
 - ✓ Investment for a high pressure electric blower = 500 USD
 - ✓ Return on Investment = Immediate



Key takeaways

- Often energy practitioners and consultants avoid assessing manufacturing processes in detail when conducting energy assessments, whereas most significant and sustainable energy savings are found in the manufacturing processes
- When assessing any process, first step is to develop an Input-Process-Output diagram or an energy balance of that process. This reveals many facts about the nature and manner of energy use and thus opens new avenues for energy saving

Key takeaways

- Identify which manufacturing process are significant energy uses (SEUs) and develop their Input-Process-Output diagrams with quantification of energy balance
- Identify which variables significantly affect energy performance of these processes
- Calculate cost impact of the energy NPOs / wastes
- Select improvement measures to reduce energy NPOs and calculate their financial payback

**Deutsche Gesellschaft für
Internationale Zusammenarbeit (GIZ) GmbH**

Registered offices
Bonn and Eschborn

Friedrich-Ebert-Allee 32 + 36
53113 Bonn, Germany
T +49 228 44 60 - 0
F +49 228 44 60 - 17 66

Dag-Hammarskjöld-Weg 1 - 5
65760 Eschborn, Germany
T +49 61 96 79 - 0
F +49 61 96 79 - 11 15

E info@giz.de
I www.giz.de