



# Environment Friendly Techniques for Textiles Industries

overview, approach and case examples

June, 2015





# Environment Friendly Techniques for Textiles Industries

overview, approach and case examples

June, 2015



**giz** Deutsche Gesellschaft  
für Internationale  
Zusammenarbeit (GIZ) GmbH





## Content

Chapter 1: Introduction.....	8
1.1 Introduction to the Indian Textile Industries.....	8
1.2 Distribution of Textile Industry and Clusters in India .....	9
1.3 Textile Manufacturing Processes .....	9
1.3.1 Preparation of fibre.....	9
1.3.2 Spinning – Conversion of fibre into yarn .....	11
1.3.3 Weaving and Knitting – Manufacturing of textile from yarn .....	11
1.3.4 Colouring and Finishing of Textiles .....	13
1.3.5 Mass balance of typical cotton textile industries .....	15
1.4 Key Environmental Issues in General .....	15
1.5 Environmental Regulatory Framework .....	15
1.5.1 Environmental Regulatory Agencies .....	15
1.5.2 Acts, Rules and Directives .....	17
Chapter 2: Approach to Pilot Work in Gujarat .....	18
2.1 Methodology.....	18
2.2 Cooperation Landscape .....	19
2.3 Processes.....	20
Chapter 3: Experiences from the Pilot Work .....	31
3.1 Textile Industries in Gujarat.....	31
3.2 Brief about the Ahmedabad Textile Cluster.....	32
3.3 Brief about the Surat Textiles Cluster.....	32
3.3.1 Challenges identified.....	32
3.3.2 Potential solutions - environment friendly techniques .....	32
Chapter 4: Case Examples .....	37
References .....	59

## Foreword



**Dr. Dieter Mutz**

Director

Indo German Environment Partnership (IGEP) Programme

Deutsche Gesellschaft für Internationale Zusammenarbeit (GIZ) GmbH New Delhi

The on-going Indo German Development Cooperation has “urban and industrial environmental policy & management” as one of priority areas of cooperation. The Indo German Environment Partnership (IGEP) Programme forms a part of this priority area, under which technical cooperation is being provided to the identified Indian partner organizations by the Deutsche Gesellschaft für Internationale Zusammenarbeit (GIZ), on behalf of the German Ministry for Economic Cooperation and Development (BMZ).

The Indo German Development Cooperation has “urban and industrial environmental policy & management” as one of priority areas of cooperation. The Indo German Environment Partnership (IGEP) Programme forms a part of this priority area, under which technical cooperation was provided to the identified Indian partner organizations by the Deutsche Gesellschaft für Internationale Zusammenarbeit (GIZ) GmbH, on behalf of the German Federal Ministry for Economic Cooperation and Development (BMZ).

The IGEP Programme, which is implemented jointly by the Ministry of Environment, Forests and Climate Change (MoEF&CC) of the Government of India and GIZ, has a thrust area on Sustainable Industrial Development (SID). Under the SID component, “Environment Friendly Techniques in Identified Industry Sectors” is one of the core topics. In India, the Small and Medium Enterprises (SMEs) make up for a very large part of the industrial profile and are often characterised by the use of outdated/inefficient technologies and production processes resulting in pollution problems. The major forms of pollution include air pollution, water pollution, soil contamination, noise pollution, and thermal pollution. For the SMEs, constraints on using modern and environment friendly technologies vary from shortage of capital, limited access to technology, underdeveloped infrastructure, inadequate research and development, and the lack of awareness on the options available to them for pollution prevention and control.

The overall objective of the technical cooperation on the core topic of ‘Environment Friendly Techniques in Identified Industry Sectors’ is, “The use of environment friendly technologies and techniques is promoted in selected SME sectors”.

The pilot activities taken up in the textiles industries in Gujarat had positive results. The present document is an effort to put together information on the pilot work undertaken under the IGEP Programme. We hope, the document will be useful for the policy makers, regulators and the industry alike for improving environmental performance in the textiles sector.

June 29, 2015

New Delhi

(Dr. Dieter Mutz)

## Preface

The overall purpose of this document is to facilitate the policy makers, regulators and the industry alike for improving environmental performance of the textiles sector in the country. The document is an effort to put together information on the problems faced by the textile sector and draws a special attention to case examples of environment friendly technologies available.

The data and information collected from secondary sources as well as interactions with industries, technology suppliers and other relevant experts from the field was useful in preparation of this document. The assessment of the problems of concern in the textiles sector was undertaken through:

- Baseline surveys and situation analysis in the textile sector;
- Stakeholders' consultations undertaken through State/regional/local level workshops and meetings; and
- Visits to the volunteering textiles industries in the textiles clusters in Ahmedabad and Surat in Gujarat.

For the volunteering industries, detailed process analysis (including water and material balance) was carried out to identify the waste streams and related environmental issues. Potential solutions were then explored for the identified environmental issues by referring documents like BREF (Best Available Techniques REFerence)<sup>1</sup> documents from EU, solutions available in the market, cleaner production measures implemented in industries by the Gujarat Cleaner Production Centre (GCPC), International case examples and national/local case examples; and consultation with experts/consultants. The commercially available technologies in the market, as informed by the industries, were looked into. Also, consultations were also made with the GCPC and the Gujarat Pollution Control Board (GPCB) in finalising the applicable technologies/techniques.

Following is the chapter-wise summary of the document.

**1. Chapter – Introduction:** This chapter describes background and overview of the textile industry in India, depicting various textile processes involved in preparation of textiles fabric in a first part and looks into the environmental regulation framework in a second step.

**2. Chapter – Approach to Pilot Work in Gujarat:** The methodology, stakeholder landscape and processes of implementing environmental friendly techniques in the textile industry in Gujarat are outlined in this chapter.

**3. Chapter – Findings – Focus on Textile Industry in Gujarat:** Chapter three put its focus on the Textile Industry in Gujarat with its structure, its challenges regarding environmental impact and improvement potentials. Moreover, it has a look at technical solutions to improve the efficiency of the textile sector in regard to water, energy and material consumption as well as reduction of pollution.

**4. Case examples:** In this chapter pilot cases from the Gujarat textile sector are presented as success stories. The implementation experiences are presented in the similar line as adopted from the EU-BREF documents, focusing amongst others on environmental, social and economic benefits.

---

<sup>1</sup> European Commission, 2003, Reference Document on Best Available Techniques for the Textiles Industry, [http://eippcb.jrc.ec.europa.eu/reference/BREF/txt\\_bref\\_0703.pdf](http://eippcb.jrc.ec.europa.eu/reference/BREF/txt_bref_0703.pdf)

# Chapter 1: Introduction

## 1.1 Introduction to the Indian Textile Industries

The Indian textiles industry is one of the largest textiles industries in the world. Today, the textile manufacturing and exports is making significant contribution to the Indian economy. India earns about 27% of the foreign exchange from the exports of textiles. Further, the Indian textile industry contributes about 14% of the total industrial production of India. The Indian textile industry involves around 35 million workers directly and it accounts for 21% of the total employment generated in the economy.

According to the statistics released by the Ministry of Textiles, the entire textile industry is highly fragmented except in the spinning sub-segment. More than 95% of spinning is in organised sector and, hardly 5% is in weaving fabric. The small scale industries perform the bulk of weaving and processing operations. The unorganised sector forms the bulk of textile industry, comprising handlooms, powerlooms, hosiery and knitting, and also readymade garments including khadi and carpet-manufacturing units. The organised mill sector consists of spinning mills involved only in spinning activities and composite mills where spinning, weaving and processing activities are carried out under a single roof. These organised sector units are mostly independent and small scale in nature and unlike the composite units that undertake all activities together.

The textile industries are classified on the basis of textile materials being processed. Various textile substrates commonly come across are:

- Cotton;
- Artificially-made cellulose fibres like viscose;
- Artificially-made synthetic fibres like polyester and acrylic fibres; and
- Natural polymers like wool and silk.

The fabric production rose to 60,996 million sq.m. in FY<sup>2</sup> 2011 from 52,665 million sq.m. in FY 2007. The production of raw cotton grew to 32.5 million bales in FY 2011 from 28 million bales in FY 2007, while production of artificial fibre rose to 1,281 million kg in FY 2011 from 1139 million kg in FY 2007. The production of yarn grew to 6,233 million kg in FY 2011 from 5,183 million kg in FY 2007.

The structure of the textile industry is extremely complex with modern, sophisticated and highly mechanized one on one hand, and the hand spinning and hand weaving (handloom) sector on the other. Between these two is the small scale power loom sector. The latter two are together known as the decentralized sector. Over the years, the government has granted a whole range of concessions to the non-mill sector as a result of which the share of the decentralized sector has increased considerably in the total production. Of the two sub-sectors of the decentralized sector, the power loom sector has shown faster rate of growth. In the production of fabrics, the decentralized sector accounts for roughly 94%, while the mill sector has a share of only 6%.

The contribution of the textile industries to the Indian economy may be summarized as below:

- Second largest producer of textiles and garments, after China;
- Second largest producer of cotton in the world;
- Second largest employer in India after agriculture – direct employment to 35 million people;
- Constitutes about 12% of India's exports;
- Contributes about 14% to industrial production;
- Contributes about 4% to GDP; and
- Investment made in the textile sector since launch of the textile up-gradation funding (TUFs) scheme is Rs.208,000 crores till June, 2010.

---

<sup>2</sup> Fiscal year



## 1.2 Distribution of Textile Industry and Clusters in India

There were 1,828 mills in the organised sector in India as on January 2009. Of these, 177 mills were composite mills and 1,651 mills were spinning mills. The cloth production in the organised mills sector has increased from 1,496 million sq.m. in 2002-2003 to 1,796 million sq.m. in 2008-09. Despite the increase in production, the organised sector contributes merely 3% to the total fabric production of the country. The remaining 97% of the fabric is produced in the unorganised sector.

Tamil Nadu is the leading State in India in terms of textiles and garments industries. Tamil Nadu had 35% (5,601) of total registered textiles and garments industries at the end of 2004-2005. Maharashtra and Gujarat are the second and third leading States in terms of number of registered industries with 11% (1,811) and 10% (1,660) market share respectively at the end of 2004-2005. The States of Tamil Nadu, Gujarat and Maharashtra together accounted for 56% of total industries in the country in 2004-2005.

There are more than 70 textiles and clothing clusters in India. These clusters contribute about 80% of total production. There are 39 power loom clusters and 13 readymade garment clusters in India. Bhiwandi and Malegaon are the two largest power loom clusters. The major readymade garments clusters are located in Delhi, Mumbai, Gurgaon, Nagpur, Madurai and Salem with annual turnover of more than Rs. 1000 crores<sup>3</sup> in 2003.

## 1.3 Textile Manufacturing Processes

In general, the entire textiles manufacturing process can be described in five different stages of production, as given below:

- Preparation of fibre: natural (e.g. wool, cotton) and manmade i.e. cellulosic (e.g. rayon, acetate) and synthetic (e.g. polyester, nylon).
- Conversion of fibre into yarn (spinning).
- Manufacturing of textile from yarn (weaving and knitting).
- Colouring and finishing of textiles.
- Garmenting by cutting and stitching.

The following sections describe each of these stages of production.

### 1.3.1 Preparation of fibre

#### 1.3.1.1 Natural fibres

The natural fibres must be opened, blended, carded and/or combed and drafted before spinning. The main steps used for processing wool and cotton are briefed below. Although the equipment used for cotton is designed somewhat differently from that used for wool, the machinery operates in essentially the same fashion.



**Image no. 2: Raw Cotton**

[Source: Retrieved from :  
<http://sff.arts.ac.uk>]



**Image no. 1: Fibre**

[Source: Retrieved from :  
[http://www.indianetzone.com/24/cotton\\_indian\\_fibre](http://www.indianetzone.com/24/cotton_indian_fibre)]

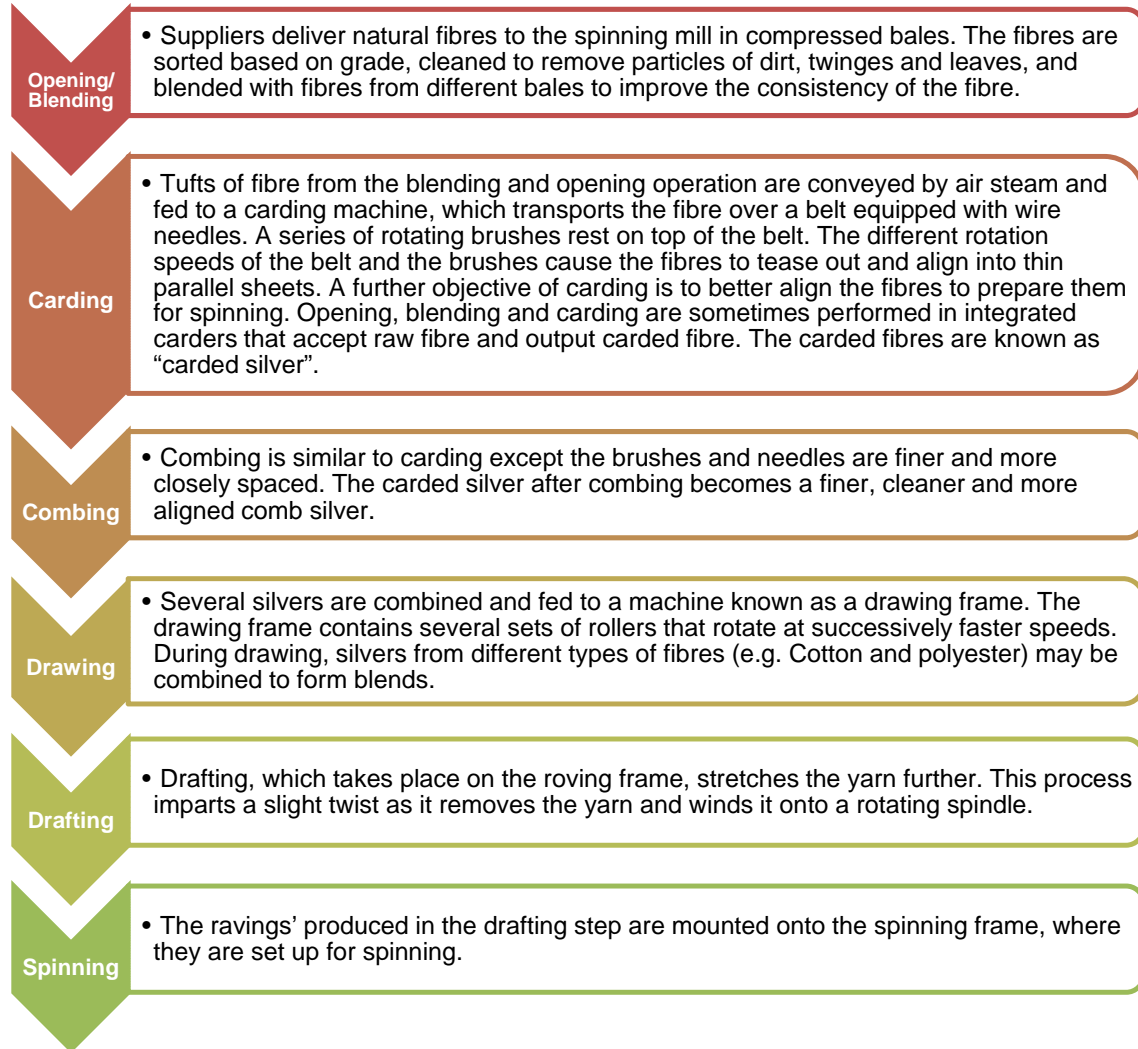

### 1.3.1.2 Man-made fibres

The manmade fibres (both synthetic and cellulosic) are manufactured by processes that simulate or resemble the manufacturing of silk (i.e. forcing a liquid through a small opening where the liquid solidifies to form a continuous filament). The main methods of fibre manufacturing are described below.

**Image no. 3: Man-made fibres**

[Source: Retrieved from: <http://buddhaj Jeans.com/lexicon/man-made/>]



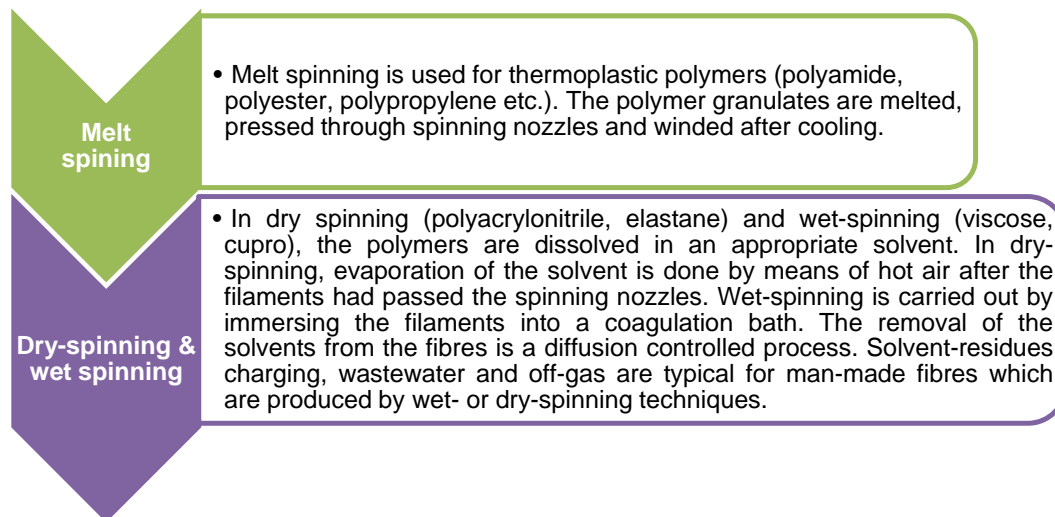

After the spinning process, the filaments are drawn to increase the orientation of the macromolecules and thereby the tensile strength of the yarns.

### 1.3.2 Spinning – Conversion of fibre into yarn

The formation of spun yarn is done in spinning mills. Before spinning preparatory processes take place, the tasks of the processes are opening of the fibre bales, mixing of the fibres, cleaning, arrangement, paralleling of the fibres, drafting, and twining of the fibres to a yarn. Ring spinning is the most important technology (80 % of worldwide yarn production). The open end technique is the mostly used non-conventional spinning technology.

The natural fibres as well as the man-made staple fibres are produced into yarns with different types of spinning systems. The kind of system used depends on the fibre length, fibre thickness, and the end use of the product. In all technologies mentioned below, the last step is carried out on ring spinning or non-conventional spinning machines:

- Cotton spinning technologies (all fibre types (esp. cotton) up to 40 mm length).
- Worsted spinning (wool and long staple man-made fibres (esp. polyester and polyacrylonitrile)).
- Semi worsted spinning (important for coarse wool and long staple man-made fibres (esp. for polyamide and polyacrylonitrile)).
- Woolen spinning (universal technique for wool and fine man-made fibres).

The differences between these techniques are based on type and number of the spinning preparatory steps (drafting, combing etc.). Some yarn qualities are twisted (two or more yarns are twined up). From the environmental point of view it is to be taken into account that during spinning and twisting lubricants and twisting oils may be applied, which are responsible for pollution loads in wastewater and off-gas in finishing (especially in pre-treatment processes).

### 1.3.3 Weaving and Knitting – Manufacturing of textile from yarn

#### 1.3.3.1 Weaving

‘Weaving’ means to interlace two or more yarn systems crosswise and perpendicular. On the weaving machine (loom), the weft yarn is inserted into the lengthwise oriented warp yarns (shed). Before the weaving process starts, some preparatory processes have to be carried out. At first, the loom beam has to be prepared. The warp yarns have to be assembled with the help of direct warping machines or sectional warping machines. Sectional warping is used for small highly patterned qualities. With

respect to ecology it is important that warping oils are sometimes used in sectional warping and that, in most cases, beam warping is related to the sizing process. Most of the spun yarns and the main part of filament yarns have to be sized before weaving. Sizing is carried out in the weaving mill to protect the warp yarn during the weaving process from damage or break. The size forms a protective film on the warp yarn; protruding fibre ends causing loom stops are minimized. Sizing is done with help of sizing machines (slashers). The yarns unreel from warp beams are impregnated in the sizing box with the hot sizing liquor, surplus of size is removed by squeezing rollers, the yarns are subsequently dried and assembled to the loom beam.

In finishing the sizes (and also warping oils) have to be removed from the fabric leading to the main charge in the wastewater drainage of finishing mills. Due to different machinery manufacturers and different fabric qualities (fineness of yarns, fabric density, fabric pattern etc.) different kinds of looms are used in weaving mills:

- Eccentric looms (simple weave patterns);
- Dobby machines (more kind of weave patterns); and
- Jacquard machines (most kind of weave patterns).

The weft insertion is carried out with the following techniques:

- Shuttle
- Projectile
- Rapier
- Water jet
- Air jet
- Special weft insertion techniques
- Circles weave technique

The size add-on on the warp yarns depends, besides some parameters of the yarn, on the type of weaving machine used, respectively, on the weft insertion rate. The woven textiles are used in all textile sectors (apparel, home textiles, and technical textiles).

### 1.3.3.2 Knitting

Knitted textiles are fabrics, which are made of yarns or yarn systems by stitch formation. Flat knitting, circular knitting, and warp knitting technologies exist. Besides the use in apparels (esp. jumpers, underwear, hoses) and home textiles (esp. net curtains), knitted textiles are also used for industrial textiles. Knitting oils used in the process are of ecological interest in downstream processing steps (esp. pre-treatment in textile finishing mills).



**Image no. 4: Knitting process**

[Source: Retrieved from: <http://www.thehindubusinessline.com/opinion/credit-rating-and-textile-industries/article2916683.ec>]

### 1.3.4 Colouring and Finishing of Textiles

The processes of colouring and finishing are generally known as dyeing and printing process. In India, the textile finishing mills are known as dyeing and printing mills. The main processes in textile dyeing and printing mills are summarized below. Depending on the demanded end-use properties of the textile all or only some of the above-mentioned processes are carried out.



**Image no. 1: Dyeing Process**

[Source: Retrieved from <http://conservationmagazine.org/2012/05/a-better-way-to-dye/>]

#### Pre-treatment



Pre-treatment: In pre-treatment steps natural impurities on the textile raw material (greige, grey goods) e.g. by-products on cotton as waxes, proteins etc., vegetable impurities on wool but also by-products from upstream production steps (preparation agents; sizing agents etc.) and fibre specific by-products from man-made fibres (monomers, fibre solvents) are removed. These by-products together with the auxiliaries and chemicals used in pre-treatment cause a considerable ecological load in the wastewater as well as in the off-gas.

#### Dyeing



In dyeing, textiles are brought into contact with aqueous dyestuff solutions, variety of chemicals (salts, acids, etc.) and dyeing auxiliaries (surfactants, dispersing agents, leveling agents, etc.). The type and quantity of dyes, chemicals and auxiliaries are substrate specific and depend on the product quality (e.g. fastness properties), as well as on the type of installed machinery.

Coloration with dyes is based on physico-chemical equilibrium processes, namely diffusion and sorption of dye molecules or ions. These processes may be followed by chemical reactions in the fibres (e.g. reactive dyestuffs react with the fibres, metal complex dyestuffs generate complexes with the fibre molecules, vat- and sulphur dyes have to be re-oxidized). Dyeing is carried out in continuous and semi-continuous processes or batchwise.

Exhaust dyeing: In exhaust dyeing, the material is brought into contact with the dyeing liquor (water with dissolved or dispersed dyes and textile auxiliaries) in a dyeing machine. The dyes wear out from the dye bath and absorb on the fibres. The dyeing equilibrium depends on temperature, time, pH and textile auxiliaries. After dyeing, the exhausted dye bath is discharged and, depending on the kind of substrate, quality to be achieved, and dyestuff used, rinsing, soaping, and special after treatment processes take place. The dyeing of fabrics is possible in rope form (skein dyeing) or in full width. Different kinds of dyeing machines are available.

Important parameters in exhaust dyeing are:

- Liquor ratio (kg textile to be dyed/l water used in dyeing bath)
- Dyeing method (temperature/time curves; two bathes or one bath method in case of fibre mixtures)
- Dyestuff type, auxiliaries
- Exhaustion degree of dyestuffs

- Amount of rinsing bathes and kind of after treatment needed
- Energy and cooling water consumption

Semi-continuous dyeing: In semi-continuous dyeing (pad-jig, pad-batch, pad-roll), the fabric is impregnated in a padding machine with the dye-liquor and afterwards treated batch wise in a jigger or stored with slow rotation for several hours (pad-batch: at room temperature; pad-roll: at elevated temperature in a heating chamber) for fixation of the dyes on the fibre. After fixation, the material is washed and rinsed in full width on continuous washing machines.

Continuous dyeing: In continuous processes, the dyestuffs are applied in a padding mangle to the material with direct subsequent dye fixation by means of chemicals, heat, or steam followed by washing steps. Pad-steam processes (padding and fixation by steaming) and thermosol processes

(padding of disperse dyes with subsequent heating) are commonly used.



**Image no. 5: Textile Process** [Source: Retrieved from <http://texchem.co.kr/?p=573>]

## Printing

Besides dyeing, colorization in textile industry is possible by means of printing technologies, mainly used for multicolour patterns. The most common printing technologies are:

- Direct printing
- Discharge printing
- Resist printing

Direct printing is the most common approach for applying a colour pattern. It is done on white or previously dyed fabrics (generally in light colours to make the print stand out); in this case it is called overprinting.

In discharge printing, a local destruction of a dye applied in a previously step takes place. If the etched areas become white, the process is called white discharge. If the printing paste contains reduction resistant dyes, the etched areas become coloured (coloured discharge technique). In the case of resist printing, a special printing paste (resist) is printed onto the textile to prevent dyestuff fixation. In subsequent dyeing, only the non-reserved areas are coloured.

Various printing paste application methods are applied, such as the following:

- Roller printing
- Flat screen printing
- Rotary screen printing
- Transfer printing
- Ink jet (emerging technique)

Roller printing is a technique with recessed (engraved) printing forms. In flat screen-printing, the printing paste is transferred to the fabric through openings in specially designed screens. The openings correspond to the pattern when the printing paste is forced through by means of a squeegee.

Rotary screen printing uses the same principle, but instead of flat screens the printing paste is transferred through lightweight metal foil screens which are made in the form of cylinder rolls.



In transfer printing (mainly done on PES), the environmental loads during textile printing are minimized. The patterns in transfer printing are transferred from a paper support to the fabric by means of heat. Ink jet printing on textiles can be carried out as jet printing on papers. Nowadays, this technique is used for small lots and patterning.



**Image no. 6: Rotary Screen Printing** [Source: Retrieved from <http://textilelearner.blogspot.in/2012/01/rotary-screen-printing-machine-working.html>]

**Finishing** Mechanical, thermal, and chemical treatments performed on fibres, yarns, and fabrics after pre-treatment, dyeing or printing are summarized as 'finishing'. Finishing improves the functionality and the handle of the textile. Some finishing processes are specific for a special substrate (easy-care finishing on cotton, antistatic finishing for textiles made of man-made fibres).

### 1.3.5 Mass balance of typical cotton textile industries

Process mapping and detailed mass balance provides a clear picture on the water consumption, raw materials and chemicals used, and waste and waste water generation. As an example, a mass balance sheet of the wet processes from a representative cotton textile industry in Gujarat is presented in Fig. 1 below. It shows that water usage is significant in textile industry. Keeping in mind that water is a precious resource, efforts need to be undertaken to reduce its consumption and increase efficiency.

## 1.4 Key Environmental Issues in General

There are various environmental issues concerning the textiles industry. The most obvious ones are resource consumption, e.g. water and energy, and environmental pollution such as due to wastewater generation and atmospheric emissions. The high consumption of water is characteristic for the textiles industry. Water is used in various processes of fabrication until colouring and finishing of the final product. These processes are also directly related to the use of high doses of chemicals, e.g. dyeing processes. Moreover, the high thermal energy input, inefficient processes and machinery as well as missing recovery systems lead to intensive energy consumption with potential negative impacts on the environment.

## 1.5 Environmental Regulatory Framework

The following section summarizes very briefly the environmental management framework in India.

### 1.5.1 Environmental Regulatory Agencies

The **Ministry of Environment, Forest and Climate Change (MoEFCC)** is the nodal agency in the administrative structure of the Central Government for the planning, promotion, co-ordination and overseeing the implementation of India's environmental and forestry policies and programmes.

The primary functions of the Ministry are related to formulation and implementation of policies and programmes relating to conservation of the country's natural resources including its lakes and rivers, its biodiversity, forests and wildlife, ensuring the welfare of animals, and the prevention and abatement of pollution. While implementing these policies and programmes, the Ministry is guided by the principle of sustainable development and enhancement of human well-being.

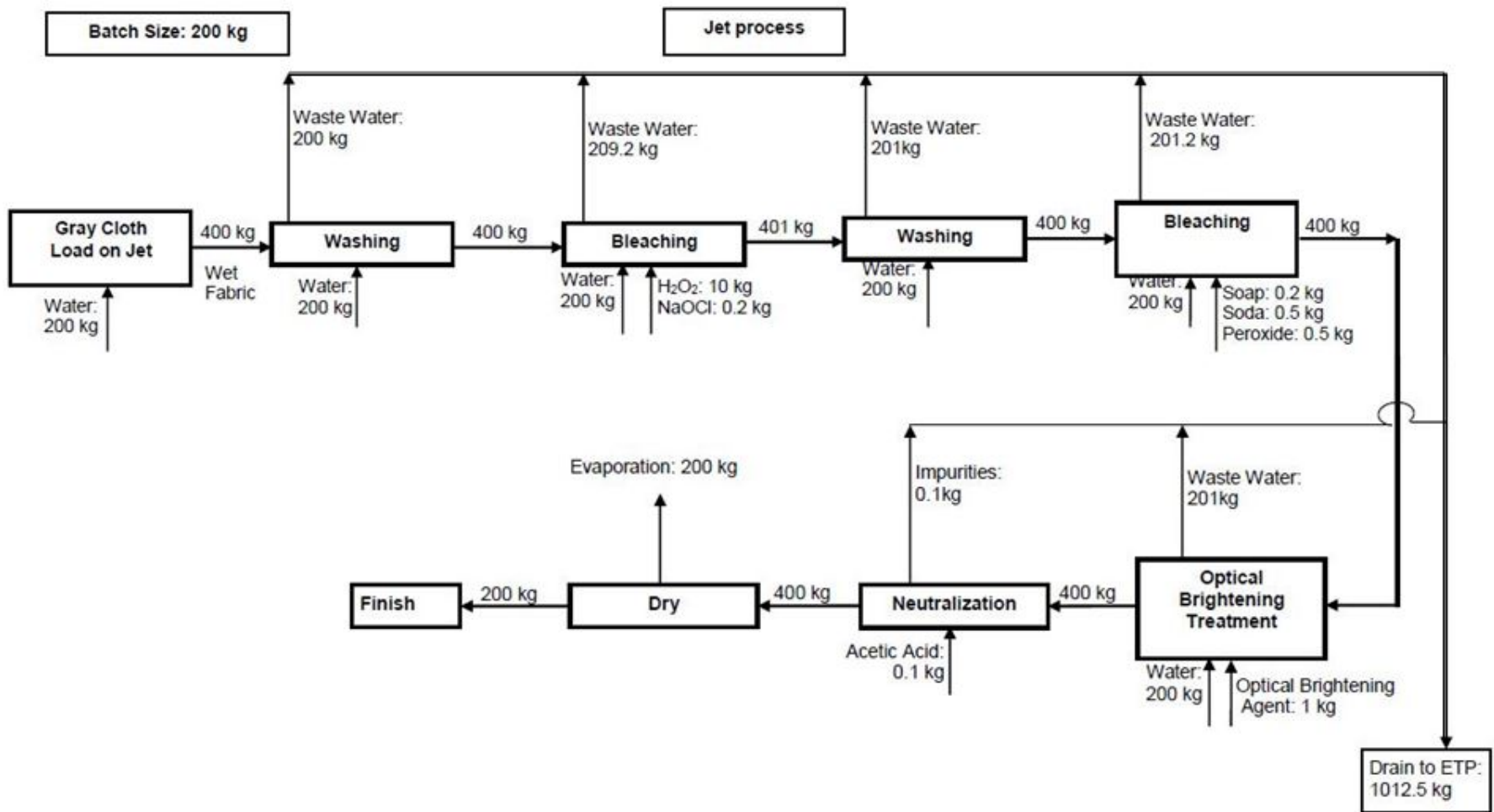

Figure no. 1: Mass balances of the Wet Processes of a Typical Cotton Textile Industry  
[Source: GIZ-IGEP and GCPC team]



The **Central Pollution Control Board (CPCB)** was constituted in September 1974 under the Water (Prevention and Control of Pollution) Act, 1974. Further, CPCB was entrusted with the powers and functions under the Air (Prevention and Control of Pollution) Act, 1981. It serves as a technical & field organization and also carries out as directed by the Ministry of Environment and Forests under the provisions of the Environment (Protection) Act, 1986. Principal functions of the CPCB, as spelt out in the Water (Prevention and Control of Pollution) Act, 1974, and the Air (Prevention and Control of Pollution) Act, 1981 are, (i) to promote cleanliness of streams and wells in different areas of the States by prevention, control and abatement of water pollution, and (ii) to improve the quality of air and to prevent, control or abate air pollution in the country.

**The State Pollution Control Boards (for Gujarat State - Gujarat Pollution Control Board)** aim at protecting the environment by preventing and controlling pollution by effective law enforcement and by adopting best environmental management practices to keep the State on the course of sustainable development.

### 1.5.2 Acts, Rules and Directives

The major environmental laws of relevance for the textiles sector are:

- The Water (Prevention and Control of Pollution) Act, 1974
- The Water (Prevention and Control of Pollution) Cess Act, 1977
- The Air (Prevention and Control of Pollution) Act, 1981
- The Environment (Protection) Act, 1986, and various relevant Rules notified thereof:
  - The Hazardous Waste (Management, Handling and Transboundary) Rules, 2008;
  - The Manufacture, Storage and Import of Hazardous Chemicals Rules, 1989;
  - The Coastal Regulatory Zone Notification, 1991;
  - The Environmental Clearance [including EIA - Environment, Impact Assessment] for expansion/modernisation of activity or new projects Notification, 2006;
  - The Environment Public Hearing Rules, 1997;
  - The Bio-Medical Waste (Management and Handling) Rules, 1998;
  - The Rules for the Manufacture, Use, Import, Export and Storage of Hazardous micro-organism.
  - Genetically Engineered Organism Cell, 1989;
  - Plastics Manufacture, Sale & Usage Rules-1999 as amended 2003;
  - Utilisation of Fly Ash - Notification of Directions, 1999;
  - The Noise Pollution (Regulation and Control) Rules, 2000;
  - The Ozone Depleting Substances (Regulation and Control) Rules, 2000;
  - The Municipal Solid Waste (Management and Handling) Rules, 2000;
  - The Batteries (Management & Handling) Rules, 2001;
  - The Environmental Audit Scheme, 1996; and
  - The Public Liability Insurance Act, 1991.

The Central Pollution Control Board (CPCB), is an apex body for prevention and control of pollution in India. It advises the Ministry of Environment, Forest and Climate Change of the Government of India on the matters of prevention and control of pollution and co-ordinates the activities of the State Pollution Control Boards.

The State Pollution Control Boards (for Gujarat State - Gujarat Pollution Control Board) implement various environmental laws for prevention and control of pollution.

## Chapter 2: Approach to Pilot Work in Gujarat

### 2.1 Methodology

The main steps involved in demonstration of solutions regarding environmental friendly techniques in textile industry on pilot basis included the following (ref. Figure no. 2 below):

- Mapping of core issues
- Consultation on Solutions
- Demonstration of pilot measures
- Documentation
- Capacity Building

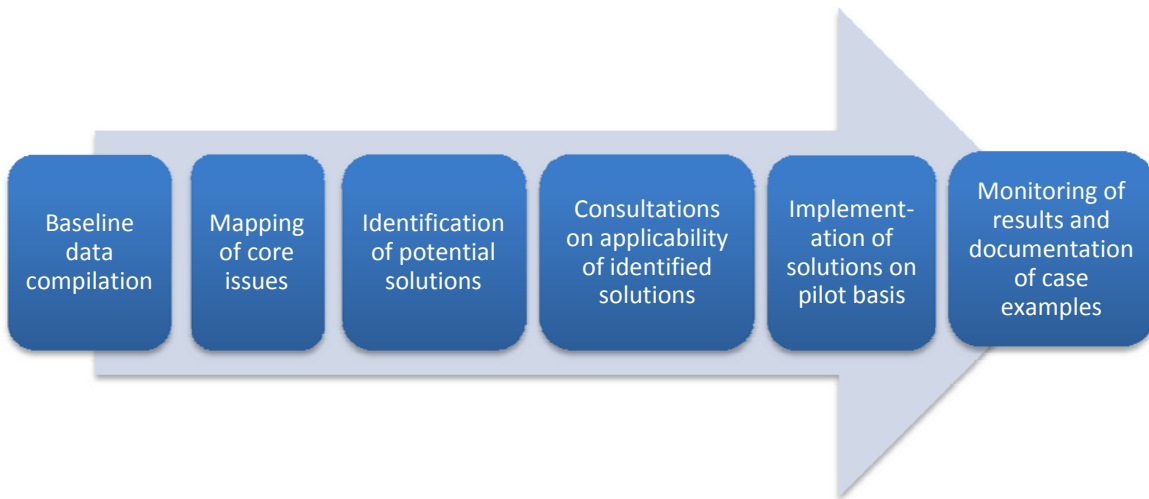

**Figure no. 2: Various steps followed in designing and execution of pilot measures**

The identification of core issues was the first step to evaluate so as to have an indepth understanding on the problem and its cause in the selected textile industry. Once this had been done, the identification of and research on appropriate solutions was carried out and an overview about the different possible measures was prepared. The demonstration of pilot measure was done through volunteering industries and this followed documentation and monitoring of the implemented measures.

Many successful trainings and brainstorming sessions were organised that helped consolidating the pilots that are useful for the specific industries from Ahmedabad. The University of Applied Sciences of Northwestern Switzerland also helped sharing inputs with the industries on best practices on effluent treatment and resource efficiency.

In order to identify environmental issues, environment friendly techniques and technologies for the textile sector in India, following methodology was adopted:

- Data and information collection, through secondary sources as well as interaction with GPCPC, NPC, GPCB, FICCI, CII and other relevant expert organisations.
- Industrial visits (mainly industries in Narol Industrial Area from the sector) to justify and ensure, the relevance with environmental issues identified from secondary sources and requirement of environment friendly techniques and technologies with respect to water usage, chemical usage, energy consumption, effluent / waste water management, raw material and solid waste management.
- Collection of relevant information from UBA/BREF reports, CPCB, NPC etc. on available environmental friendly techniques commercially available and proven for the sector.

The following core environmental issues were identified:

- Issue 1: Less efficient electrical equipment
- Issue 2: Inefficient water recovery & reuse
- Issue 3: Waste water generated from various washing sections
- Issue 4: Management of chemical usage
- Issue 5: Inefficient boiler operation
- Issue 6: High thermal energy losses through uninsulated areas, improper condensate recovery
- Issue 7: High heat loss through dryer
- Issue 8: Waste due to manual operations

In a second step the reasons for these environmental issues were looked into closely. The results were the basis to propose further measures to reduce resource consumption and negative impact of textile sector on society and the environment.

For evolving the potential solutions following were explored and consulted:

- BREF (best available techniques reference) documents from EU;
- Cleaner Production measures implemented in industries by the Gujarat Cleaner Production Centre;
- Solutions available in the market;
- International case examples and national / local case examples; and
- Local and national technical consultants also were consulted while analysing the possible solutions on their suitability and feasibility.

## 2.2 Cooperation Landscape

It was important to understand various stakeholders associated for making the pilot demonstration successful and eventually ensure their replication. Different stakeholders were associated, who had different interests and roles to play in the implementation of environmental-friendly techniques in the textile sector. They were identified and integrated systematically in the processes to make the promotion of the environment-friendly technique as effective and efficient as possible.

The key stakeholder was the Ahmedabad Textile Processors Association (ATPA) that played most important role in the processes. ATPA brought to the table the representation of the larger industrial community and ensured that all the relevant industries are invited and participate in the consultation process. GIZ and the Gujarat Cleaner Production Centre (GCPC) played a very important role in providing technical support and supporting the steering and other processes.

GCPC being locally present had a very good understanding of the industries, cleaner production measures and were experienced in taking up cluster level interventions. The whole initiative was aptly supported by the Gujarat Pollution Control Board (GPCB), which provided the regulatory perspective from the utility of environmental friendly techniques and greatly encouraged the participation process from the industries. As international knowledge support, the German Federal Environment Agency (Umwelt Bundes Amt) supported the activity by seeing through the lens of 'Best Available Techniques' as perceived in the European context. A local consultant (Enpro Envirotech & Engineers Pvt. Ltd.) was engaged for providing technical inputs during the process study and evolving of solutions to test on pilot basis. The consultant also participated as an expert in various consultation and dissemination processes. The textiles industries in Ahmedabad were the first targeted industry group for implementation of the environment-friendly techniques on pilot basis and the textiles industries in Surat were then targeted for replication of the successfully implemented measures.

<b>Key Stakeholders</b>	<ul style="list-style-type: none"> <li>Ahmedabad Textile Processors Association</li> <li>Gujarat Cleaner Production Centre (GCPC)</li> <li>GIZ</li> </ul>	<ul style="list-style-type: none"> <li>Lead the steering processes and initiated discussions for application of the approach in other key industry sectors in Vapi.</li> <li>Technical support and support steering processes</li> <li>Technical support, training, support to steering processes</li> </ul>
<b>Primary Stakeholders</b>	<ul style="list-style-type: none"> <li>Volunteering textiles industries in Ahmedabad</li> <li>Gujarat Pollution Control Board (GPCB)</li> </ul>	<ul style="list-style-type: none"> <li>Implementation pilot cases.</li> <li>Regulatory mechanisms for up-scaling successful pilot cases.</li> </ul>
<b>Secondary Stakeholders</b>	<ul style="list-style-type: none"> <li>GIZ's national and international consultants</li> <li>UBA (German Federal Environmental Agency)</li> <li>Service providers and technology providers</li> <li>Textiles industries in Surat</li> </ul>	<ul style="list-style-type: none"> <li>Technical services.</li> <li>Technical input on best available techniques (BAT)</li> <li>Information input</li> <li>Replication of measures</li> </ul>

Figure no. 3: Cooperation landscape

### 2.3 Processes

With the task in hand, it was not enough to be “doing things right” (i.e. to be efficient) but also to be careful about “doing the right things” (i.e. effective). Towards this, well strategised processes were put in place. These included steering processes, core processes and auxiliary processes as shown in Figure no. 2.

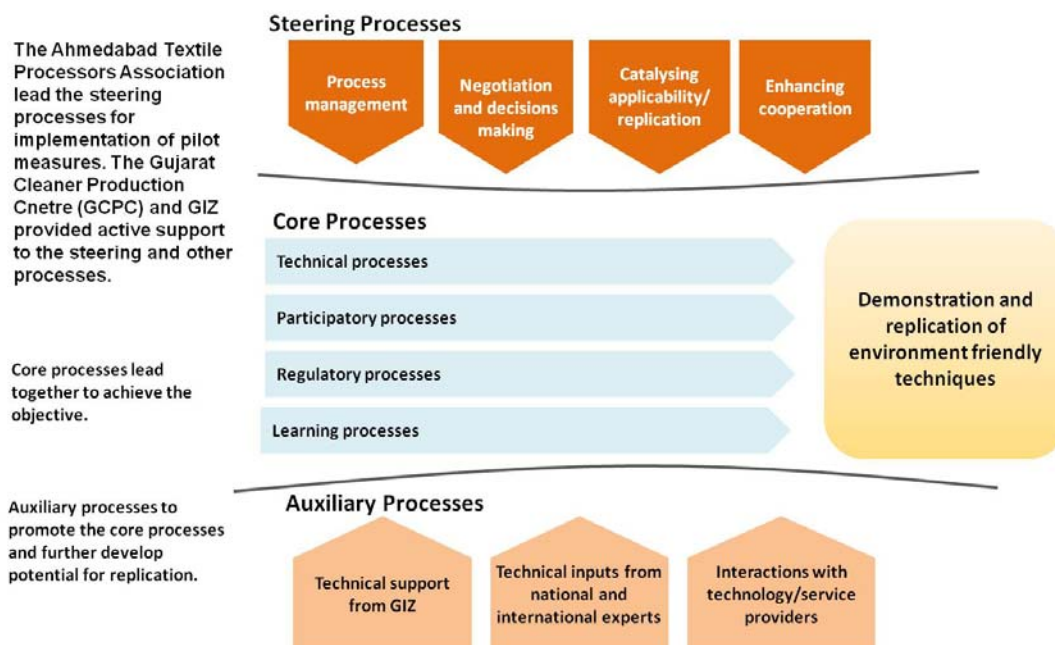

Figure no. 4: Processes landscape

The processes were also supported by certain formal arrangements. To promote state-of-the-art environmental management and pollution control in the state of Gujarat, a Memorandum of Understanding (MoU) was signed between GIZ (IGEP) and the Gujarat Pollution Control Board on April 06, 2013 to promote state-of-the-art environmental management and pollution control in the state of Gujarat.



**Image no. 7: Signing of MoU between GIZ-IGEP and GPCB**

GIZ, GPCB and German Federal Environmental Agency (UBA) agreed to cooperate through a Joint Declaration of Intent (JDI) for promotion of Best Available Techniques in the identified industry sectors of Gujarat. The JDI was signed in June, 2013 and renewed in February 2015 with validity until July 2015. The overall objective of the cooperation among the three partners was to facilitate promotion of Best Available Techniques (BAT) without entailing excessive cost in various industry sectors in India so as to strengthen environmental management and pollution control in the industries in these sectors.

#### ► **Steering processes**

ATPA, with the President of the association and office bearers lead the steering processes, which mainly included:

- Process management, including support to core processes and auxiliary processes.
- Collation of industry specific information and on implemented measures
- Negotiating on and decisions making to support participation of industries.
- Enhancing cooperation among partners and stakeholders.

GIZ played a very crucial role in guiding and supporting the steering process. GCPC played a very important support role by closely interacting with ATPA. GIZ engaged national consultants for undertaking process study at the participating units together with team of GCPC. GPCB and GCPC facilitative the process of participation of the industries.

#### ► **Core processes**

The core processes that were the essential inputs of the project to the development goal, were unique in nature and delivered a direct contribution towards achieving the project objectives. The core processes included technical processes, participatory processes, regulatory and learning regulatory processes. Brief details are given below.

##### **a) Technical processes:**

Various activities that were undertaken as part of the initiative are as following:

- In line with the adopted approach, IGEP took baseline survey and/or situation analysis to identify exact problems to be tackled in the selected industry sectors of textiles, and pulp and paper. Based on this, appropriate pilots are planned and implemented in these sectors in selected areas to demonstrate and generate knowledge on innovative and financially sustainable solutions.

The baseline study was undertaken through desk study. The overall objective of the baseline study / situation analysis was to identify the environmental issues related to textile sector, with respect to the techniques and technologies being used and to highlight the immediate need of the sector, in order to do their business in sustainable manner and also to identify environment friendly technologies and techniques available commercially and proven through various sources.

The results from analysis of the baseline data was discussed in various meetings, roundtables and workshops with various stakeholders.

- Studies were then taken up in the volunteering industries. The Ahmedabad Textile Processors' Association identified voluntarily willing industries to participate in the pilot activity and be willing to implement pilot measures. Detailed study was undertaken by GIZ and GCPC in the eight representative units that volunteered. GIZ team initially carried out preliminary investigations in eight representative textile industries of Ahmedabad and later attempts were made to arrive at "material balance" in each of the industries to identify material usage, wastes/waste water generated, efficiencies of unit operations etc. However, as was not easy to accomplish due to lack of proper monitoring system, desk research was carried out to understand "material balance". Majority of the participating industries seldom monitor the extent of water usage or effluent generated. Based on the data of six consecutive months, information was collated through available checklists and information was developed on specific water consumption, wastewater discharge and trends and overall yield.

After the study, industry specific diagnostic reports were prepared, including certain historical track record on production, energy consumption, water consumption, effluent disposal, waste generation etc. These diagnostic reports were used to plan "Pilot Projects" for implementation and additional advisory inputs were provided.

- Documentation was undertaken on the pilots implemented and the results were periodically updated through the participating industries. The industries proactively came up to verify the benefits, viz. cost savings, energy savings, reduced pollution etc. in a quantified manner.
- A web based Knowledge Platform was set up to disseminate information, reports and the results.
- Policy dialogue was undertaken with GPCB, industry representatives, industrial associations and experts for development of state and local level relevant standards, rules and policies. GPCB took an active role on this, while GIZ and GCPC undertook technical work to support the discussions.

#### **b) Participatory processes:**

The participatory processes included roles of various stakeholders at various stages of implementation of the project. The stakeholders' consultations were facilitated through workshops at national/state/local levels and information on environment friendly techniques is shared and exchanged.

- **State level Workshop in Ahmedabad:**

A one day state level workshop was conducted at Ahmedabad region in April 2013. In this workshop mapping of environmental issues that was carried out by consultant was discussed in

length and was screened out for sorting the most critical one. Possible solutions for mitigating the issues were also discussed.



Image no. 8: State level workshop at Ahmedabad, April 2013

- **Regional level Workshop in Vatva:**

A regional workshop on “Environment Friendly Techniques in Textile Sector” was held on March 01, 2013 at Center of Excellence (COE), GIDC Industrial Estate, Vatva (Gujarat). The workshop aimed at gathering inputs for identifying core issues associated with environmental improvements and identifying actions needed for enabling improved performance in the textile sector. Representatives of the government, pollution control authorities, textile industry, technology providers, academicians, consultants and research bodies were present.

- **Round Table at Delhi**

A half-day round table was held on September 2013 at GIZ Office in New Delhi to understand the need for environmental improvement in the Textile Sector in India and plan strategic actions, GIZ-IGEP organised half day Round Table Discussions on 9th September, 2013 at GIZ Office in New Delhi.

The participants included representative from MoEF&CC, CPCB, Industries Association and research institutes. Critical environmental issues and the studies/ schemes related to textile industries were discussed to chalk out a list of issues and the possible solutions thereof.



Image no. 9: Round table discussions at Delhi, September, 2013

### ▪ Regional level Round Tables

To understand the need for environmental improvement in the textile Sector in Gujarat and plan strategic actions, a half day Round Table was held in January, 2013 at Ahmedabad. The participants included textile industry members, GCPC Officials and GIZ-IGEP Officials. The 'Ahmedabad Textile Processors' Association' decided to take lead in steering the whole process of implementation of 'environmental friendly technology' for textile industries in Ahmedabad. Similar round tables were eventually held in Surat and Jetpur, where textiles industries had good presence.



Image no. 10: Round table discussions at Ahmedabad, January, 2013

The main outcomes from the entire participatory process were:

- Mapping of the critical environmental issues relevant for individual industries and the textiles sector as a whole.
- Discussions on most relevant solutions to address the identified critical environmental issues.
- Identification of industries on voluntary basis for pilot demonstration.
- Evolving a replication strategy based on results/benefits from implementation of the solutions.

#### c) Regulatory processes:

The regulatory processes included:

- Seeking information on statutory requirements and understanding the environmental compliance requirements.
- Assessment of environmental compliance scenario and the gaps therein.
- Discussions on developing new environmental regulatory conditions and prescribing them as consent conditions.

The implemented solutions on pilot basis, which were largely accepted by the paper industries in Vapi, were discussed for generalisation as regulatory measures so as to prescribe as 'consent' conditions. Following are the consent conditions that were developed for strengthening environment protection and pollution control in textiles industry in Gujarat.



**Table: Proposed consent conditions for textiles industries**

S. No.	Proposed conditions	Applicability
1.	Optimum combustion efficiency of the boilers/ thermic fluid heaters above 85 % to be ensured through continuous online monitoring of CO <sub>2</sub> & CO with appropriate air fuel ratio control (manual / automation).	Applicable to all textile process house categories
2.	Side plates of drying range to be insulated with more durable (life & properties) insulation except glass wool.	Applicable to all textile process house
3.	Exhaust moisture controlling system to be installed at stenter.	Applicable
4.	Cooling water from jet machines should be recycled completely, for example as boiler feed water or as hot water to other application in process and cannot be drained to sewage / ETP.	Applicable to all cotton textile process house
5.	In jet dyeing machine, batch / intermittent washing to be applied with fresh water intake of three cycles in batch manner instead of continuous flow of water with manual practice or automation in machine.	Applicable to all polyester / blend textile process house
6.	In jigger machine timer based flow control valve should be installed for water filling and overflow operations in existing line or install two separate lines (high diameter for filling and low diameter for overflow) with timer based flow control valve for filling and overflow to control water consumption at jigger machines.	Applicable to all cotton textile process house
7.	Fresh water should not be used for cleaning of screen/frames, blanket & strapper etc. at printing machines, ETP treated water will be used for all cleaning operations at printing area.	Applicable to all textile process house
8.	In jigger machine, auto temperature control valves to be installed at steam supply line at existing jiggers or separate hot water line to be installed at jiggers to supply water directly at required temperature to avoid overheating or loss of steam.	Applicable to all cotton textile process house
9.	Caustic water should not be drained to sewer/ETP. The caustic water should be either reused in other process applications or recovered and reused through caustic recovery plant.	Applicable to all cotton textile process house
10.	Condensate generated in indirect heating application (Drying ranges, Printing Dryer, Ager, Hot screen table, Jigger for temperature maintaining, Kier, Jet machine) should be recovered through condensate recovery system and sent back to boiler and should not be drained to sewer / ETP.	Applicable to all textile process house

During the consultation process with the Industries, it was expressed these consent conditions should be considered as guidelines rather than making it mandatory. It was agreed to take up these consent conditions case by case with the existing industries individually at the time of renewal of consent by GPCB and prescribe on voluntary basis. If most industries adopt the consent conditions, the conditions could then be made compulsory for all industries in one to two years time.

**d) Learning processes:**

The learning processes helped in evolving the best suitable environmental measures and also in disseminating the implementation procedure. The learning processes included:

- Training of the industry managers and operators
- Training of GPCB officials in appreciating role of EFT in pollution mitigation
- Dissemination workshops at Ahmedabad, Surat and Jetpur.

Following are the main activities carried under this process:

- **2-day training programme on “Environmental Friendly Techniques for Textiles Sector” for GPCB Officials on November 19-20, 2013, Gandhinagar, Gujarat**

The objective of the two days training programme from the regulatory bodh's perspective was to facilitate promotion of Best Available Techniques (BAT) without entailing excessive cost in various industry sectors which would strengthen the environmental management and pollution control in the industries of these sectors. The participants were from relevant field offices and unit heads of GPCB.

- **1-day training cum awareness programme on “Environmental Friendly Textile Production for Process House Masters” on December 23, 2013, Surat, Gujarat**

A one-day training programme on ‘Environmental Friendly Textile Production for Process House Masters’ was organized on 23rd December, 2013 at Surat, Gujarat. The training programme focused on techniques to be adopted for textile process house masters in textile industry and areas of intervention to achieve compliance. The training programme had participants from the textile Industry with special focus on process house masters.



**Image no. 11: Glimpse of training programme at Surat, December, 2013**

- **2-day training programme on “Environmental Friendly Techniques for Textile Sector” on November 21-22, 2013, at Center of Excellence, Vatva GIDC, Ahmedabad**

The 2-day training programme was held for the environmental managers and process managers of the textile industries. The training had experts from UBA (German Federal Environmental Agency) as resource persons. The key aspects that were covered in the training programme were as follows:

- Best Available Techniques in the textile sector – European experience
- Process improvements for dyeing and finishing operations
- Techniques for waste water treatment
- Measures for reduction of water consumption and process water recycling
- Techniques for recovery of process chemicals and auxiliaries (e.g. caustic soda, salt, sizing agents)
- Substitution of hazardous chemicals
- Techniques for the reduction of energy consumption (e.g. heat recovery)



Image no. 12: Glimpse of training programme at Ahmedabad, November, 2013

- **2-day Training on “Environment Friendly Techniques in Textile Sector” on September 29th & 30th, 2014; Narol, Ahmedabad, Gujarat**

An interactive 2-day training session on “Environment Friendly Techniques in Textile Sector” was conducted by GIZ-IGEP in cooperation with the Gujarat Pollution Control Board (GPCB) and the Gujarat Cleaner Production Centre (GCPC) on September 29-30, 2014 at Ahmedabad, Gujarat. The training was intended to facilitate the textile industry cluster of Ahmedabad with skills, knowledge and awareness on environment friendly techniques so as to enable them replicate the pilot measures implemented in some of the textile industries. The target group included representatives of textile industry (15 nos. of industries), the Gujarat Pollution Control Board, the Ahmedabad Textile Processors Association and the Gujarat Cleaner Production Center (GCPC).





Image no. 13: Glimpse of training Programme at Ahmedabad, September, 2014

- **Workshop & Meetings on “Environmental Friendly Techniques for Textile Sector” of Gujarat by UBA on April 17-18 & 20-21, 2015, Surat, Gujarat**

A 3-day brainstorming session with the GPCB nominated ‘Working Group’ was organised to discuss the status and way forward on the ‘Reference Document’ in collaboration with GPCB and the Gujarat Cleaner Production Centre (GCPC) together with active support from the experts from the German Federal Environmental Agency, UBA.



Image no. 14: Meeting & Workshop at Surat, April, 2015

- **“Knowledge Platform on Environment Friendly Technologies for Industries”**

A Knowledge Platform was set up to provide access to reference documents, case studies, guidelines, presentations and other relevant information related to ‘Environmental Friendly Technologies’ that could be useful for the textile and pulp & paper sectors.

The Honb’le Chief Minister of Gujarat, Mrs. Anandiben Patel launched the “Knowledge Platform on Environment Friendly Technologies for Industries” on June 5, 2014 at GIDC Industrial Estate, Vatva

(Gujarat) on the occasion of the World Environment Day. Link for the knowledge platform is. [www.gpcb-kp.in](http://www.gpcb-kp.in)

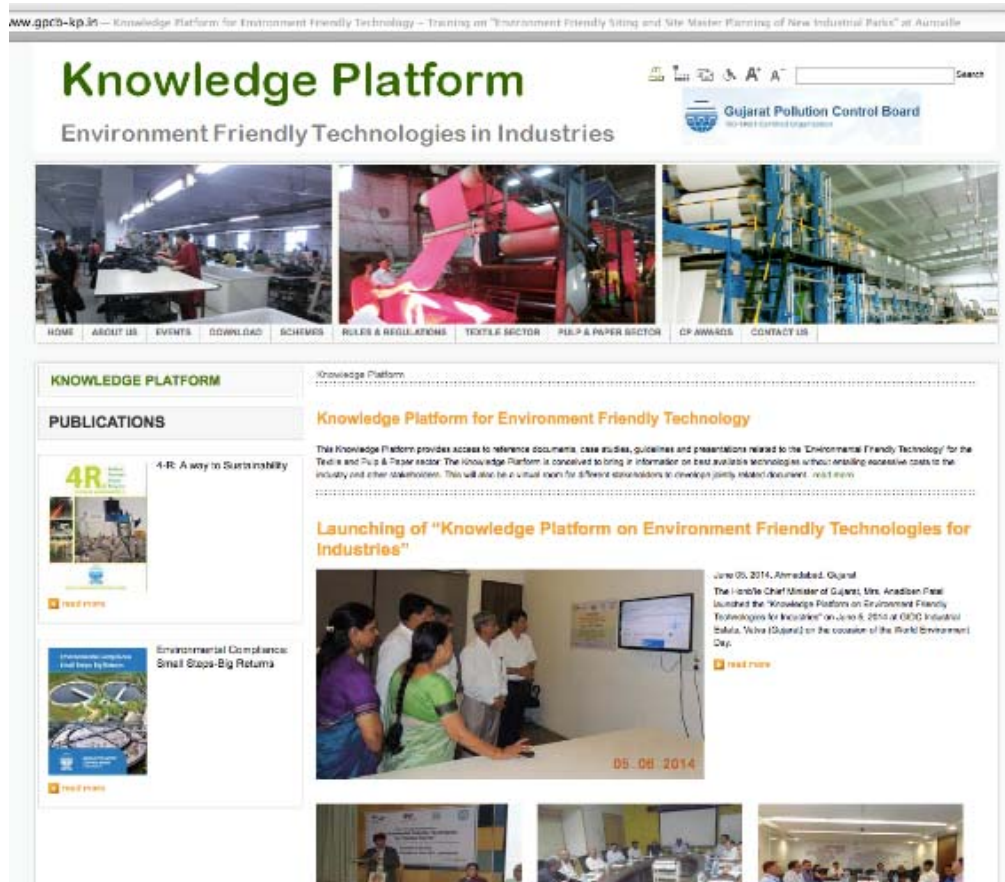

Image no. 15: Snapshot of knowledge platform

- Roundtable on “Environment Friendly Technologies in Textile Sector” held on July 07 to 09, 2014; Ahmedabad, Surat & Jetpur Gujarat



Image no. 16: Roundtable at Ahmedabad, Surat & Jetpur, July, 2014

The environmental friendly technologies that were implemented in various textile industries of Ahmedabad were discussed and the way forward for replication as well for improving of environmental status in other textile industries in Surat and Jetpur were discussed in these respective round tables.

▶ **Auxiliary processes**

The auxiliary processes provided the back-up and support that facilitated and enabled the other processes to operate. These included:

- Technical support from GIZ, including suggestions on setting up of the processes, guiding through various processes and providing trusted opinions for taking decisions at various stages of action plan preparation.
- Consultations with national and international experts for multi-sectoral inputs, benchmarks/standards, and for review and feedback of the action plan at various stages of its development.
- Interactions with technology/service providers to understand the viable solutions available and their implementation.



## Chapter 3: Experiences from the Pilot Work

### 3.1 Textile Industries in Gujarat

Gujarat is one of the leading industrial States in India and textile industry in particular had contributed in a big way to the industrialization of the State. The textile industry growth in Gujarat can be judged by the fact that in 2001 Gujarat produced 23 lakh bales of cotton and a decade later the figure stands at 1 crore 23 lakh bales.

The development of many industries like dyestuff, chemicals, engineering/foundry and cotton farming is dependent on this textiles sector. The State is well known for development of hybrid cotton, ginning, power looms, composite mills, spinning units and independent processing houses. Overall economic growth of the State is very much dependent on this sector. As per the report of Gujarat Pollution Control Board (GPCB), 24% to 28% of fixed investment, production value and employment of the SSI sector in Gujarat are from the textiles alone. Further, 23% of Gross State Domestic Product (GSDP) comes out of textiles industry in the State. With 16% of the cultivated land area of the State for cotton, the Gujarat is the largest cotton producer State in the country. About 30% of woven fabric from organized sector and 25% of decentralized power loom sector of the country comes from this State alone.

In Gujarat, large fabric process houses are concentrated in Ahmedabad (250) and Surat (350). Jetpur is also another cluster having small to medium size textile units. The State accounts for 12% share of the total textile exports of the country. A large number of garment units and garment processing units are developed in the urban areas of the State. Gujarat is a State where various types of textile processes in different clusters exist and bears a special significance in the overall textile production scenario of India. The locations of major textile clusters of Gujarat are shown in figure below.



Image no. 17: Textile Cluster in Gujarat

There are five major clusters, which hold textile industries in Gujarat. They are as follows:

- Ahmedabad Cluster – Dominated by Cotton Industry
- Surat Cluster – Dominated by Polyester based textile industries
- Vapi Cluster – Having mixed and garment textile industries
- Kachchh Cluster – Having handprint textile industries
- Jetpur Cluster – Having dyeing and printing textile industries

### **3.2 Brief about the Ahmedabad Textile Cluster**

Ahmedabad was known as the Manchester of India. Ahmedabad is located in one of the highly industrialized and urbanized parts of Gujarat State. It is the seventh largest metropolis in India.

Ahmedabad is an industrial centre with large-scale cotton textile industries. The entrepreneurial environment created by the local financial elite was largely responsible for founding the modern textile industry in the city.

Majority of the industries are of medium and large scale. Arvind Mills is the second largest denim manufacturer in the world. The integrated textile industry is engaged in production of yarn, fabric and finished goods from raw fibres. Initially, raw fibres are transformed into yarn, thread or webbing. Then the yarn is converted into fabric in looms. Fabric is then dyed or printed to convert into finished product. In short, the process flow includes fibre manufacturing / preparation, yarn manufacturing, fabric production and finishing processes. The raw materials used in textile manufacturing include natural fibres, different chemicals (organic or inorganic) and the utilities required are water & energy. The industry is water intensive and labour intensive.

### **3.3 Brief about the Surat Textiles Cluster**

The textile processing industry has flourished leaps and bound in South Gujarat, particularly in Surat district. There are nearly five lakhs power looms in Surat, which consume yarn of about four lakhs metric tons in preparing the grey fabrics.

About two crores meters of grey textile is manufactured daily in Surat. Today, there are about 450 dyeing and printing units located in and around Surat in various clusters - Pandesara, Sachin, Kadodara and Palsana. These dyeing and printing units are engaged in processing of man-made fabrics, i.e. dyeing, bleaching, printing and finishing of grey fabrics. Mostly these units are processing the grey fabrics on job work basis.

The industrial units receive grey fabrics from the traders and process the fabrics as per their requirement. There are about 150 wholesale markets in Surat. The city of Surat is now known as "Silk City". The sequence of various operations is almost same, however they depend on the product quality and product pattern.

#### **3.3.1 Challenges identified**

The challenges identified are:

- High water consumption - water consumption in wet processing varies from 146-250 litre/kg of fabric processed.
- High thermal energy consumption – the thermal energy consumption in wet processing varies from 7,739-14,617 kCal/kg of fabric processed.
- High wastewater generation - waste water generation in wet processing varies from 146-250 Litre/kg of fabric processed with increased load
- High dose of chemicals & auxiliaries usage- These practices results in high environment impacts.
- Inefficient processes & machinery

#### **3.3.2 Potential solutions - environment friendly techniques**

The environmental concerns of the textile industry are centred on the textile processing, which generates wastewater during the process, mainly of dyeing. The implementation of environmental friendly techniques aims at directly or indirectly mitigating the potential negative impact of the various industrial operations. These measures may be linked to either the processes or the equipment used.

The European IPPC Bureau, under 'Integrated Pollution Prevention and Control' Directive/ Act, has prepared reference documents on Best Available Techniques Reference Documents, called BREFs. This is for use by member countries in Europe for the purpose of issuing operating permits for the installation of significant pollution potential.



The conclusions of Best Available Techniques (BAT) do not prescribe the use of specific techniques, but a level of environmental protection that can be achieved by the application of BAT.

Processes covered by BREF	Environmental issues covered
<ul style="list-style-type: none"> <li>• Fibre preparation</li> <li>• Pre treatment</li> <li>• Dyeing</li> <li>• Printing</li> <li>• Finishing</li> </ul>	<ul style="list-style-type: none"> <li>• Waste water</li> <li>• Emission to air</li> <li>• Energy consumption</li> <li>• Solid and liquid waste</li> <li>• Hazardous material management</li> </ul>

BREF textile industry document includes description of 130 techniques in the chapter 04 "Techniques to consider in the determination of BAT". The BREF (07.2003) document for textiles Industry is available at link<sup>4</sup>.

Further resources, which were also studied and analysed for identifying the potential solutions are:

- Cleaner Production measures implemented in industries by the Gujarat Cleaner Production Centre;
- Solutions available in the market;
- International case examples and national / local case examples; and
- Local and national technical consultants also were consulted while analysing the possible solutions on their suitability and feasibility.

From the above sources, a list of possible solutions was identified against the environmental issues and after consultation with industry experts, technology supplier and consultants few solutions were zeroed in for pilot testing.

The solutions may be categorized in the following major categories:

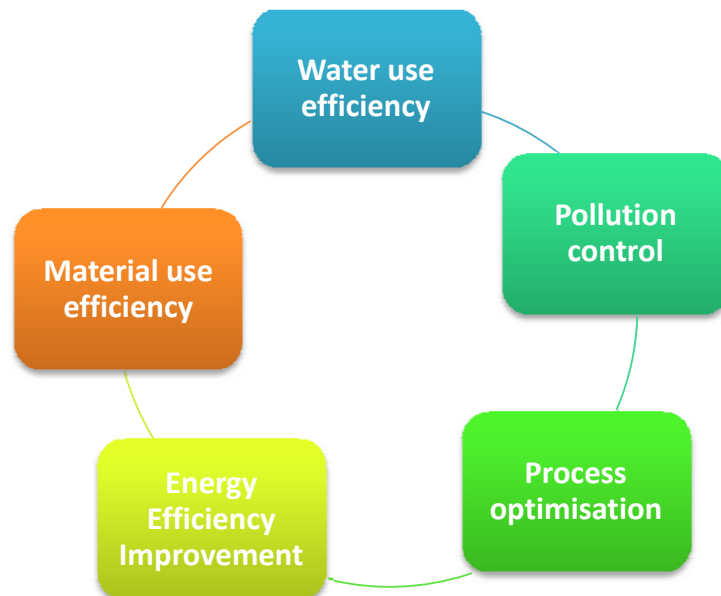

<sup>4</sup> European Commission, 2003, Reference Document on Best Available Techniques for the Textiles Industry, [http://eippcb.jrc.ec.europa.eu/reference/BREF/txt\\_bref\\_0703.pdf](http://eippcb.jrc.ec.europa.eu/reference/BREF/txt_bref_0703.pdf)

## ▪ **Water efficiency**

The textile industrial processes are water-intensive and environmental friendly techniques comes handy in increasing the water use efficiency and employing these measures saves considerable water and water-related costs.

Though at times they are costly, return on investment on most water efficiency methods can be relatively short. A comprehensive audit is helpful in assessing a facility's water system and identifies locations where these practices can be employed to conserve water.

One of the processes to conserve water is the reuse of water by collecting from various bleaching operations. The acid wash water collected is used in chemick wash. The chemick wash water collected is used in keirwash and de-size wash. A counter current system in washing machine saves water.

Many factors influence washing efficiency (e.g. temperature, residence time, liquor/substrate exchange, etc.). The techniques applied in modern washing machines depend largely on the type of fabric to be washed, e.g. light or very heavy fabrics, etc. Two basic principles/strategies are applied in modern washing machines: counter current washing and reduction of carry-over.

The counter current principle means that the least contaminated water from the final wash is reused for the next-to-last wash and so on until the water reaches the first wash stage, after which it is discharged. This technique is relatively straightforward and inexpensive and can be applied for washing after continuous de-sizing, scouring, bleaching, dyeing or printing [11, US EPA, 1995].

A washer configuration with internal counter current (and recycling) capabilities is the vertical counter-flow washer, which sprays recirculated water onto the fabric and uses rollers to squeeze waste through the fabric into a sump, where it is filtered and recirculated. This construction allows for high-efficiency washing with low water use. Energy use decreases greatly because less water must be heated [11, US EPA, 1995].

The reduction of carryover is another fundamental factor. The water (containing contaminants) that is not removed is "carried over" into the next step, contributing to washing inefficiency. Proper extraction between steps is essential. In continuous washing operations, squeeze rollers or vacuum extractors (more efficient) are used to reduce drag-out and carry-over [11, US EPA, 1995]. The wash boxes with built-in vacuum extractors are available for purchase as well as after-printing washers that combine successive spray and vacuum slots without any bath for the fabric to pass through [11, US EPA, 1995].

More measures to reduce water consumption are listed below:

- Recovery and Reuse of Sizing Agents
- Replacement of starch in de-sizing
- One-step de-sizing sourcing and bleaching
- Water reuse
- Reuse of water from Bleaching Process
- Water Consumption Optimisation at Jigger Machines
- Pulsating Rinsing Technology
- Re-use Cooling Water as Process Water

## ▪ **Material use efficiency**

Material efficiency in industrial production, on the other hand can be improved either by reducing the amount of the material used in the final product, or by reducing the amount of material that enters in the overall production cycle viz. reducing the waste stream.

Substitution of raw material used in a process with an Environmental friendly one also provides positive impact both inside the process as well as in the waste generated. In the textile industries this is more specifically linked to the dyes and dye chemicals that are used in the colouring process and that's the reason this option is encouraged to explore inside the textile industries, which can provide

significantly good results in saving the environment. Most of the time, it has also been proved to make more economic sense too. Following are few options that are explored:

- Eco-Friendly Substitution in Textile
- Replacement of alkaline sourcing with bio-sourcing enzyme for enzymatic sourcing
- Use of Natural Dyes

#### ▪ **Energy efficiency**

The main areas of these processes where energy is consumed are in the heating of various baths (scouring, sizing, dyeing, rinsing, etc.) and in drying. Energy use can be high – for example, energy use for scouring may range from 4.28 to 19.98 MJ/kg. This is closely related to water consumption. Optimal use of water and energy should start from monitoring of water, heat, and power consumption. For wet processes, energy consumption is often related, because, to a great extent, energy is used to heat process baths.

- Heat recovery through re-use of cooling water
- Optimization of boiler house (condensate return, preheating of air supply, heat recovery from combustion gases)
- Install automatic controllers for fill volume and temperature in batch machines
- Boiler efficiency improvement through excess air control
- Automatic Blow down Control

#### ▪ **Process optimisation**

Through measures such as automatic controllers and variable speed control for fans and other installation processes in the textile industry can be optimized. Some of these measures that permit to save energy and resources are outlined here after:

- Automated preparation and dispensing of chemicals
- Installation of automatic controllers for fill volume and temperature
- Variable speed control for fans, blowers and pumps
- Improvement of Dyeing Process

#### ▪ **Pollution control**

Most significant pollutant related to the textile is generated from the wet processes in the form of wastewater. Several methods are employed for the treatment and disposal of waste water from textile industries. The treatment procedures are neutralization, chemical treatment (precipitation), biological treatment and advanced treatment systems. The choice of method differs from plant to plant and the method best suited for a particular plant has to be evaluated with reference to the type of wastes to be handled and the degree of treatment required. In multiple effect evaporators have been installed but found to be unaffordable due to high operating cost beside capital cost. Some of the possible waste water related techniques are presented briefly in following sub sections.

As the conventional treatment of physico-chemical and biological treatment could not fulfil the requirement of achieving desired quality of treated effluent that is suitable to discharge in water body due to high TDS<sup>5</sup> and residual COD<sup>6</sup>, the use of R.O.<sup>7</sup> for recovery of water from treated effluent and use of nano filtration for recovery of brine from concentrated dye effluent with subsequent use in process have come into practice in many textile industries. To take care of R.O rejects, the multiple effect evaporators have been installed but found to be unaffordable due to high operating cost beside capital cost. Some of the possible waste water related techniques are described in named sub sections.

---

<sup>5</sup> Total dissolved solids

<sup>6</sup> Chemical oxygen demand

<sup>7</sup> Reverse Osmosis

- Efficient Wastewater Treatment Trains
- Reduction of suspended solids load by usage of alkaline sizing agent in place of acidic sizing agent
- Reduction of suspended solids in wastewater through collection and saving system
- Fibre recovery System

For detail description of the measures, refer to the Reference Document on Environment friendly techniques in Textile Industry.



## Chapter 4: Case Examples

Pilot activities were initiated under the IGEP Programme in selected textiles industries in Narol Industrial Estate, near Ahmedabad in Gujarat. The purpose of this chapter is to highlight successful measures that have been implemented. The presentation template of the case examples is inspired by the BREF documents.

The main pilot interventions included implementation of environment friendly techniques in textile industries of Narol Industrial Area in Gujarat. The pilot implementations were based on studies and interactions with eight industries that resulted in identification of 84 pilot project ideas. Of these industries, six industries agreed to the implementation of pilot projects on short, medium and long-term basis. High technology end or new equipment-oriented options were examined, as many of the industries were with extreme low production capacity. The categories of improvement measures include:

- Chemical conservation, replacement & recycle
- Reuse of water
- Reduction in water consumption
- Energy conservation

The cumulative benefits from the implementation of pilot measures in the selected textiles industries are summarised below:

Number of pilot industries	6
Electrical energy savings (kWh/yr)	349,303
Fuel savings - coal (tons/yr)	2,027
Fuel savings - agro waste (tons/yr)	900
Process water saving (m <sup>3</sup> /yr)	193,976
Reduction in chemical usage - caustic (tons/yr)	770
Monitory savings (Rs. per year)	42,260,500

“Through the Environment Friendly Techniques project, it is evident that, small solutions to prevent pollution at source and increase of resource efficiency, helps in big way to sustain industrial development without compromising on environment”.

**Mr. Hardik Shah, IAS, Member Secretary  
Gujarat Pollution Control Board (GPCB)**



**1. Recycle/reuse of cooling water and condensate water as boiler feed water**

<p><b>Description &amp; achieved environmental benefits</b></p>	<p>Cooling water and condensate water are non-process water uses. Many cooling water systems are operated on a once-through basis. Condensate water includes water from heat exchangers in dyeing machines, drying ranges, cooling cans on continuous ranges, while cooling water includes hot water from jet dyeing machine and compressors (if water cooled). In the knit industry for example, the amount of cooling water utilized in the process is equivalent to 13% of total fill and rinse water. Traditionally, jet dyeing machines are equipped with common heat exchangers that are used for both heating and cooling which is normally drained with other effluent and thus increasing fresh water consumption as well as effluent quantity &amp; load at effluent treatment plant.</p> <p>Recycle/reuse of cooling water and condensate water as boiler feed water resulted in the following benefits:</p> <ul style="list-style-type: none"> <li>- Boiler feed water consumption reduction: <b>100%</b> (depending on recovered quantity).</li> <li>- Recovery of energy in form of heat from hot water: <b>15%</b> minimum</li> <li>- Reduction in boiler emissions.</li> <li>- Reduction in waste water generation (quality &amp; quantity).</li> </ul>	
<p><b>Cross-media effects</b></p>	<p>This technology does not affect chemical use, but because effluent volume is reduced, the concentration of chemicals in the effluent will increase.</p>	
<p><b>Operation data</b></p>	<p>The total boiler feed water is being now catered by recovered condensate &amp; cooling water amounting to 50 KL per day.</p> <p>Both the cooling water and the condensate is recovered completely from jet dyeing machines and reused as boiler feed water in Rinkoo Processors. While cooling water from jet dyeing machines is reused as process hot wash water on soft flow dyeing machines, RFD (Ready For Dyeing) machines, etc. in KomalTexfab.</p>	
<p><b>Applicability</b></p>	<p>The technique is applicable to both existing and new installations. In new installations condensate recovery system and a steam boost system as a measure is considered to save water and improve energy efficiency.</p>	
<p><b>Economics</b></p>	<p>Capital costs for implementation was Rs. 3,00,000, operating costs includes the pumps operation of 10 HP<sup>8</sup> for transfer amounting to Rs. 3,13,000 per annum, resulted in saving of Rs. 33,00,000 per annum with payback period of 3 months (Rinkoo Processors).</p> <p>Capital costs for implementation was Rs. 11,00,000, while operating costs includes the pumps operation of 10 HP for transfer amounting to Rs. 1,96,000 per annum, resulted in saving of Rs. 12,12,000 (Rs. 5,94,750 fuel cost + Rs. 6,17,760 fresh water pumping cost) per annum with payback period of 13</p>	

**Image no. 18: Reuse of Recovered Condensate at Other Machines**  
 [Source: GIZ-IGEP and GCPC team]

<sup>8</sup> Horse Power

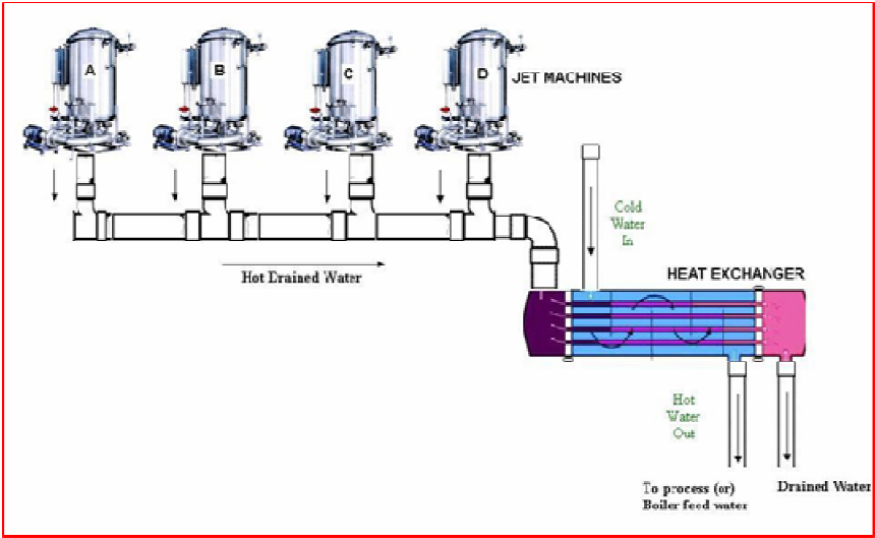
	months (KomalTexfab).
<b>Driving force for implementation</b>	Contribute to overall reduction of water and energy consumed. In order to allow full exploitation of the benefits achievable with the new advanced washing machinery, the implementation of the low-technology measures is fundamental. The main driving forces for the implementation of the described techniques are the increasing cost of water supplies and waste water treatment, and the desire for increased productivity (in the case of new highly efficient washing machinery).
<b>Example plants</b>	M/s Rinkoo Processors & KomalTexfab, Ahmedabad
<b>Reference literature</b>	 <p><b>Figure no. 5: Heat Recovery of Hot Condensate from Jet Dyeing Machine</b> [Source: Detailed Project Report on Waste Heat Recovery by BEE]</p>
<b>Reference Literature</b>	BEE, 2010, Detailed Project Report on Waste Heat Recovery System, Textile SME Cluster, Surat, Gujrat (India) & Identification and Evaluation of Best Available Technologies Economically Achievable (BATEA) for Textile Mill Effluents Submitted to: Environmental Protection Branch, Environment Canada, Submitted by: Marbek Resource Consultants.

<b>2. Reuse of Treated Water for Washing at Printing Machines</b>	
<b>Description &amp; achieved environmental benefits</b>	<p>Screen is used for printing designs. When designs or colours on design are changed screens need to be washed. Similarly the frames also need washing on change overs. One Printing machine requires 1500 lit/hr for continuous cleaning of the blanket and screens, therefore in it requires 150 KL of water per day. During washing wash water is generated, which is treated in ETP<sup>9</sup> finally.</p> <p>The ETP treats and recycles the water for its use in cleaning process of screen &amp; frames. In house piping arrangements were made to divert the ETP treated water for cleaning at printing machines through an overhead tank.</p> <p>- Reduced fresh water consumption by 150 KL per day</p>

<sup>9</sup> Effluent treatment plant

	<p>- Reduction of CETP charges in future for the volume of waste water reduced</p>  <p><b>Image no. 19: Picture showing Reuse of ETP Treated Water for Washing of Screens</b> [Source: GIZ-IGEP and GCPC team]</p>
<b>Cross-media effects</b>	None believed likely.
<b>Operation data</b>	<p>Operating cost for running pumps of 6 HP for water transfer were of Rs 1,69,000 per annum. (Rinkoo Processors)</p> <p>Operating cost for running pumps of 7.5 HP for water transfer of Rs 86,000 per annum.</p>
<b>Applicability</b>	The technique is applicable to both existing and new installations, provided plant is having Effluent Treatment Plant.
<b>Economics</b>	<p>Capital cost for implementation of Rinkoo Processors was Rs. 1,00,000. The total savings were of Rs 3,46,500 with payback period of 10 months.</p> <p>Capital cost for implementation of KomalTexfab was Rs. 3,00,000, giving total savings of Rs 2,58,000 with payback period of 21 months.</p>
<b>Driving force for implementation</b>	Reduced water consumption and quick to fair payback. High alkali content of waste water and economic aspects of caustic soda losses are the main driving forces.
<b>Example plants</b>	Rinkoo Processors & KomalTexfab, Ahmedabad started using the ETP water for washing purposes in 2010&Komal Texfab started using the ETP treated water for washing purpose in 2013.
<b>Reference literature</b>	Cleaner Production Implementation Project, Final Report of Textile Sector, 2010



Environment Friendly Techniques in Textile sector project was very informative and boost up the knowledge to save energy and environment in textile sector. The drive by GCPC/GIZ/GPCB is need of today to provide better environment to the existing and coming generation. The initiative by all is really appreciable.



**Mr. M. S. Gajjar, Plant Head  
Komal Textfab Pvt. Ltd.**

### 3. Water Consumption Optimisation at Jigger Machines

**Description & achieved environmental benefits**

In overflow rinsing, clean water is fed into a machine and drained through an overflow weir usually set near a normal running level. Overflow rinsing is inefficient in terms of water use as clean water is often fed into a machine with the control valve fully opened thus having 3 times (1200 litre/batch) higher flow rate of overflow water required.



**Image no. 20: Picture showing Overflow Rinsing in Textile Processing**

[Source: GIZ-IGEP and GCPC team]

In order to reduce water consumption and effluent generation two separate water lines

were installed for jigger machines, for water filling (1.5 inch) with auto timer based controller to fill required quantity of water into jigger, for overflow (0.5 inch) line with auto timer controller which allows only 400 litre per 20 minutes and stops the water flow after one turn. Also the water supplied to the jigger is from condenser cooling water of caustic recovery plant which in turn saves the 30 KL/yr of additional fresh water consumption.

Economic savings with reduced fresh water consumption by 360 KL per year

- Reduction in effluent generation due to reuse of cooling water.
- Reduces the load on ETP and reduction of CETP charges in future for the volume of waste water reduced

**Cross-media effects**

Low water consumption levels can only be achieved by synergistic combination of different possible measures, from the preparation of the fabric through the process chain (e.g. low add-on application techniques for sizing agents, selection of dyes with good washing off properties, etc.).

<b>Operation data</b>	<p>The table below shows the achievable water consumption levels for washing cotton and viscose woven fabric and their blends with synthetic fibres.</p> <p>It is worth pointing out that the achievable performances are influenced by the degree of implementation of complementary techniques.</p> <table border="1" data-bbox="505 373 1360 1058"> <thead> <tr> <th rowspan="2"></th> <th colspan="2">Water consumption (l/kg)</th> </tr> <tr> <th>TOTAL</th> <th>of which HOT WATER</th> </tr> </thead> <tbody> <tr> <td><b>Pre-treatment Processes</b></td> <td></td> <td></td> </tr> <tr> <td>Washing for de-sizing</td> <td>3 - 4</td> <td>3 - 4</td> </tr> <tr> <td>Washing after scouring</td> <td>4 - 5</td> <td>4 - 5</td> </tr> <tr> <td>Washing after bleaching</td> <td>4 - 5</td> <td>4 - 5</td> </tr> <tr> <td>Washing after cold bleaching</td> <td>4 - 6</td> <td>4 - 6</td> </tr> <tr> <td>Washing after mercerisation</td> <td>4 - 5 (hot)</td> <td></td> </tr> <tr> <td>-Washing to remove NaOH</td> <td>1 - 2 (cold)</td> <td>4 - 5</td> </tr> <tr> <td>-Neutralisation without drying -</td> <td>1 - 2</td> <td>n/a</td> </tr> <tr> <td>Neutralisation and drying</td> <td>(warm)</td> <td>&lt;1</td> </tr> <tr> <td><b>Washing after dyeing</b></td> <td></td> <td></td> </tr> <tr> <td>Reactive dyestuffs</td> <td>10 - 15</td> <td>4 - 8</td> </tr> <tr> <td>Vat dyestuffs</td> <td>8 - 12</td> <td>3 - 7</td> </tr> <tr> <td>Sulphur dyestuffs</td> <td>18 - 20</td> <td>8 - 10</td> </tr> <tr> <td>Naphtol dyestuffs</td> <td>12 - 16</td> <td>4 - 8</td> </tr> <tr> <td><b>Washing after printing</b></td> <td></td> <td></td> </tr> <tr> <td>Reactive dyestuffs</td> <td>15 -20</td> <td>12 -16</td> </tr> <tr> <td>Vat dyestuffs</td> <td>12 - 16</td> <td>4 - 8</td> </tr> <tr> <td>Naphtol dyestuffs</td> <td>14 - 18</td> <td>6 - 10</td> </tr> <tr> <td>Disperse dyestuffs</td> <td>12 - 16</td> <td>4 - 8</td> </tr> <tr> <td colspan="3">Source: [179, UBA, 2001]</td> </tr> </tbody> </table>		Water consumption (l/kg)		TOTAL	of which HOT WATER	<b>Pre-treatment Processes</b>			Washing for de-sizing	3 - 4	3 - 4	Washing after scouring	4 - 5	4 - 5	Washing after bleaching	4 - 5	4 - 5	Washing after cold bleaching	4 - 6	4 - 6	Washing after mercerisation	4 - 5 (hot)		-Washing to remove NaOH	1 - 2 (cold)	4 - 5	-Neutralisation without drying -	1 - 2	n/a	Neutralisation and drying	(warm)	<1	<b>Washing after dyeing</b>			Reactive dyestuffs	10 - 15	4 - 8	Vat dyestuffs	8 - 12	3 - 7	Sulphur dyestuffs	18 - 20	8 - 10	Naphtol dyestuffs	12 - 16	4 - 8	<b>Washing after printing</b>			Reactive dyestuffs	15 -20	12 -16	Vat dyestuffs	12 - 16	4 - 8	Naphtol dyestuffs	14 - 18	6 - 10	Disperse dyestuffs	12 - 16	4 - 8	Source: [179, UBA, 2001]		
	Water consumption (l/kg)																																																																	
	TOTAL	of which HOT WATER																																																																
<b>Pre-treatment Processes</b>																																																																		
Washing for de-sizing	3 - 4	3 - 4																																																																
Washing after scouring	4 - 5	4 - 5																																																																
Washing after bleaching	4 - 5	4 - 5																																																																
Washing after cold bleaching	4 - 6	4 - 6																																																																
Washing after mercerisation	4 - 5 (hot)																																																																	
-Washing to remove NaOH	1 - 2 (cold)	4 - 5																																																																
-Neutralisation without drying -	1 - 2	n/a																																																																
Neutralisation and drying	(warm)	<1																																																																
<b>Washing after dyeing</b>																																																																		
Reactive dyestuffs	10 - 15	4 - 8																																																																
Vat dyestuffs	8 - 12	3 - 7																																																																
Sulphur dyestuffs	18 - 20	8 - 10																																																																
Naphtol dyestuffs	12 - 16	4 - 8																																																																
<b>Washing after printing</b>																																																																		
Reactive dyestuffs	15 -20	12 -16																																																																
Vat dyestuffs	12 - 16	4 - 8																																																																
Naphtol dyestuffs	14 - 18	6 - 10																																																																
Disperse dyestuffs	12 - 16	4 - 8																																																																
Source: [179, UBA, 2001]																																																																		
<b>Applicability</b>	<p>The achievement of performances typical of highly efficient washing machines requires investment in new equipment. However, the application of low-technology measures such as flow control devices, automatic valves, etc. can also produce some reduction in water and energy consumption.</p>																																																																	
<b>Economics</b>	<p>Capital cost for the modification was Rs. 2,00,000 per jigger with water saving of 360 KL/yr. Although the fresh water cost is not significant, the payback in this case is not fast considering the fresh water cost only.</p>																																																																	
<b>Driving force for implementation</b>	<p>Water consumption reduction. The main driving forces for the implementation of the described techniques are the increasing cost of water supplies and waste water treatment, and the desire for increased productivity.</p>																																																																	
<b>Example plants</b>	<p>The modification was done in-house in 2010 by the Mukesh Industries with installation of two pipe line networks and controllers on each jigger machine.</p>																																																																	
<b>Reference literature</b>	<p>[179, UBA, 2001]</p>																																																																	

#### 4. Caustic Soda Recovery System

**Description & achieved environmental benefits**

A large quantity of caustic soda is used in different processes of textile processing of the industry, most notably in mercerization process. Mercerization is the treatment of cotton under tension with caustic soda solution at 150 - 200°C for 25- 40 seconds. For this purpose fibres and fabrics are impregnated within a caustic soda solution. Fabric is treated with caustic soda (NaOH) solution. Caustic soda reacts with the cellulose, swells it and imparts above properties.

After treatment, fabric is washed with water with starching tension to remove un-reacted caustic soda (98 to 99 % of unreacted caustic) from the fabric. This wash water contains substantial amount

of caustic soda which is not only the resource loss but also it generates pollution in the wastewater (higher COD, TDS, TSS, alkalinity etc). The alkaline load of waste water is reduced drastically and acid required for waste water neutralisation is minimised.



**Image no. 21: Installed Caustic Recovery Unit by Textile Industry**  
[Source: GIZ-IGEP and GCPC team]

**Cross-media effects**

Evaporation requires approximately 0.3 kg steam/kg water evaporated in a 4-stage evaporation plant. This corresponds to 1.0 kg steam/kg of recovered NaOH at 28 °Bé or 1.85 kg steam/kg of recovered NaOH at 40 °Bé.

**Operation data**

Capital cost for caustic recovery plant was Rs. 92,40,000 with operating costs of Rs. 48,21,000 per annum.

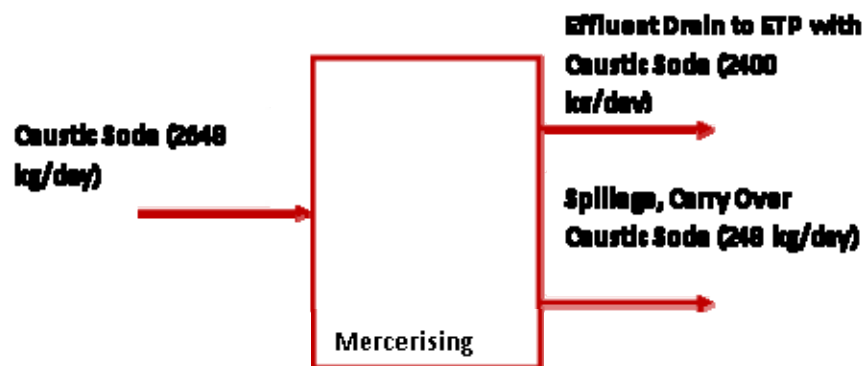

**Figure no. 6: Schematic of Mercerising Process without Caustic Recovery**  
[Source: GIZ-IGEP and GCPC team]

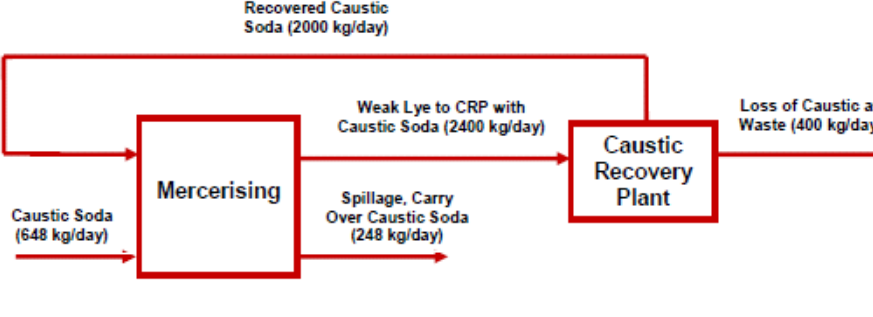
	 <p><b>Figure no. 7: Schematic of Mercerising Process with Caustic Recovery</b> [Source: GIZ-IGEP and GCPC team]</p>
<b>Applicability</b>	This measure requires an investment and construction adaptations of the existing installation, but it pays back quickly. The technique is applicable to both existing and new installations.
<b>Economics</b>	Total savings of Rs. 1,42,00,000 with payback period of 12 months. (s. Operational data). Payback time depends on plant size and operating time per day.
<b>Driving force for implementation</b>	High alkali content of waste water and economic aspects of caustic soda losses are the main driving forces.
<b>Example plants</b>	M/s ShyamCorporation, Ahmedabad. Industry implemented the caustic recovery plant in year 2013 from Elite Engineers, Thane, Maharashtra.
<b>Reference literature</b>	[179, UBA, 2001], [5, OSPAR, 1994] P040.

This project brought us the feeling that improvement is continuous process. We experienced that the best of the techniques to be implemented already exists in the sector and we are open to share the practices we follow and gain the same from others.

**Mr. Mahavir Dalmia, Director  
Anjani Synthetics Ltd.**



## 5. Caustic Batch Washing in Place of Continuous Washing in Jet

### Description & achieved environmental benefits

In Jet Dyeing Machine, the washing is carried out with continuous flow of fresh water in order to remove the unexhausted dyes and chemicals without any control. During continuous washing 5000 litre / batch of water is consumed without any real requirement and as a normal practice.

As measure batch/intermittent washing is applied with fresh water intake of three cycles in batch manner instead of continuous flow of water. Achieved by giving appropriate instruction to dyeing master and & operating staff.

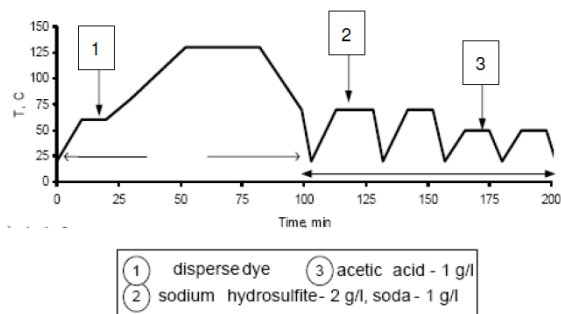

### Cross-media effects

None believed likely.

### Operation data

This method permits to achieve the same washing quality as batch washing with 3500 litre / batch of water. This is a reduction of water consumption of 30%. The reduction in water consumption was approx. 39600 KL per annum on 11 nos. machine without any capital cost or operating costs.

### Applicability

The principle described here are applicable at a general level.

### Economics

Saving of Rs. 3,05,000 per annum without any investment giving immediate return.

### Driving force for implementation

Reduction of water consumption and cost savings.

### Example plants

Rinkoo Processors, Ahmedabad implemented the batch washing in 2010.

### Reference literature

Cleaner Production Implementation Project, Final Report of Textile Sector, 2010

## 6. Replacement of alkaline scouring with bio-scouring enzyme for enzymatic scouring

<p><b>Description &amp; achieved environmental benefits</b></p>	<p>Scouring is carried out to remove impurities that are present in cotton. This is usually done at high temperatures (above 100 °C) with sodium hydroxide. Scouring produces strongly alkaline effluents (around pH 12.5) with high organic loads, tends to be dark in colour and has high concentrations of Total Dissolved Solids (TDS), oil and grease in wastewater.</p> <p>The pilot measure consisted of replacing of alkaline in scouring in the manufacturing process with bio-scouring enzyme for enzymatic scouring with chemical supplied by Camex, Ahmedabad, also available with Novozyme.</p> <p>Bio-scouring process provides many advantages, such as reduced water and wastewater costs, reduced treatment time and lower energy consumption because of lower treatment temperature. Commercial bio-scouring enzyme products are based on pectinases which are used for enzymatic scouring. Biological Oxygen Demand (BOD) and Chemical Oxygen Demand (COD) of enzymatic scouring process are 20-45 % as compared to alkaline scouring (100%). TDS of enzymatic scouring process is 20-50% as compared to alkaline scouring (100%).</p> <p>Bio scouring resulted in following benefits:</p> <ul style="list-style-type: none"> <li>- Water consumption reduction: 45.45%</li> <li>- Chemical consumption reduction: 8.65%</li> <li>- Electrical power consumption reduction: 37.04%</li> <li>- Fuel (coal) consumption reduction: 24.55%</li> </ul>	
<p><b>Cross-media effects</b></p>	<p>The environmental benefits remain unclear as enzymes contribute to the organic load and their action is based on hydrolysis rather than oxidation. The organic load not removed with enzymatic scouring may appear in the later wet processing steps. A more global balance would probably reveal no significant improvement.</p>	
<p><b>Operation data</b></p>	<p>The operational cost are the same as for scouring with alkaline. No special installation or extra staff is required as only the alkaline is replaced by a bio-sourcing enzyme.</p>	
<p><b>Applicability</b></p>	<p>As this measure only requires the replacement of alkaline by a bio-sourcing enzyme it is easy to implement. No change of the installation is needed. The enzymatic scouring process can be applied to cellulosic fibres and their blends (for both woven and knitted goods) in continuous and discontinuous processes.</p> <p>When enzymatic de-sizing is applied, it can be combined with enzymatic scouring.</p> <p>The process can be applied using jet, overflow, winch, pad-batch, pad-steam and pad-roll equipment.</p>	
<p><b>Economics</b></p>	<p>The initial processing cost of fabric was Rs. 5.15 per kg of fabric. The processing cost of fabric reduced to Rs. 3.91 per kg of fabric through the</p>	

**Image no. 22: Bio-Scouring Trial Taken in Industry**

[Source: GIZ-IGEP and GCPC team]

	replacement of alkaline scouring with bio-scouring enzyme. Thus it is economically beneficial. There is no capital cost required since only replacement of chemical is required (although with 10 % additional cost compared to existing chemicals), the total savings achieved was Rs. 50,22,000 per annum.
<b>Driving force for implementation</b>	Cost savings through reduced water, chemical, electric and fuel consumption are together with a better environmental performance the driving force of this measure. Quality aspects (good reproducibility, reduced fibre damage, good dimensional stability, soft handle, increased colour yield, etc.), technical aspects (e.g. no corrosion of metal parts) as well as ecological and economical aspects are reported as reasons for the implementation of the enzymatic scouring technique [179, UBA, 2001].
<b>Example plants</b>	The Pilot measure was implemented in M/s Mangal Textile, Ahmedabad & M/s Komal Textfab, Ahmedabad. Trials with positive results were conducted in M/s Vinod Textile, Ahmedabad; M/s Shyam Textile, Ahmedabad; and M/s Aakash Fashion, Ahmedabad.
<b>Reference literature</b>	[179, UBA, 2001] with reference to: "Kahle, 2000", Kahle, V. Bioscouring ein neues, modernes Bio Tech-Konzept Product information, Bayer AG, D-Leverkusen (2000)

<b>7. Reuse of Alkaline Stream from Mercerising</b>	
<b>Description &amp; achieved environmental benefits</b>	<p>In mercerising process, fabric is treated with caustic soda (NaOH) solution. Caustic soda reacts with the cellulose, swells it and imparts properties like strength, improve lustre and increase absorption of the fabric for dyes. The alternate to recover caustic is caustic recovery plant which requires significant capital investment and also running cost in form of steam and manpower. After treatment, fabric is washed with water with starching tension to remove un-reacted caustic soda (98 to 99 % of unreacted caustic) from the fabric. This wash water contains substantial amount of caustic soda which is not only the resource loss but also it generates pollution in the wastewater (higher COD, TDS, TSS, alkalinity etc).</p> <ul style="list-style-type: none"> <li>- Reduction of caustic consumption by 15000 kg per year.</li> <li>- Reduction of CETP charges in future for the volume of waste water reduced</li> </ul> <div style="text-align: right; margin-top: 10px;"> <p><b>Image no. 23: Overhead Tank to Store Caustic Weak Solution for Reuse at Dyeing</b> [Source: GIZ-IGEP and GCPC team]</p> </div>
<b>Cross-media effects</b>	The reuse of alkaline stream to other applications requires additional electrical energy for pumping but likely to be recovered by cost of recovered caustic.
<b>Operation data</b>	Industry has gone through the process waste stream identification and probable processes for reuse of the waste streams and after process modification, the alkaline stream is collected in underground tanks of which 500 caustic stream is collected and reused for next batch while the 200

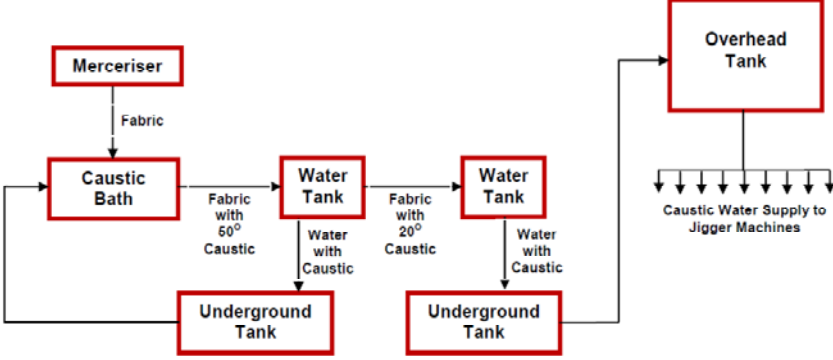
	<p>caustic stream is pumped to overhead tank and is supplied through common line with tapings to individual jigger machines for use during next process i.e., dyeing process where the alkaline stream is used for boiling and bleaching of fabrics.</p>  <p><b>Figure no. 9: Schematic of Caustic Collection and Reuse in Dyeing Process</b> [Source: GIZ-IGEP and GCPC team]</p>
<b>Applicability</b>	Generally applicable to the plants having space for additional collection tanks and have lesser production (less than 50000 m/day).
<b>Economics</b>	Capital cost for implementation was Rs. 5,00,000, with negligible operating cost giving total savings of Rs. 5,40,000 per annum with payback period of 12 months.
<b>Driving force for implementation</b>	Reduction of resource consumption and quick payback.
<b>Example plants</b>	Rinkoo Processors, Ahmedabad done installation of mercerising waste water collection tanks with piping & pumping system through In-house modification in 2010.
<b>Reference literature</b>	Cleaner Production Implementation Project, Final Report of Textile Sector, 2010

<b>8. Efficient Boiler Operation</b>	
<b>Description &amp; achieved environmental benefits</b>	<p>Boiler efficiencies will vary over a wide range, depending on a great variety of factors and conditions. The highest efficiencies that have been secured with coal are in the range of 50-82%. It is being observed that the combustion efficiency of the boiler is lower than the current standard boilers delivering, the combustion efficiency of the boiler was found to be only 80 % while the combustion efficiency of efficient boilers is more than 90 %. The reasons for low combustion efficiency are:</p> <ul style="list-style-type: none"> <li>- The heat transfer is poor due to low heat transfer area and short contact time between flue gas and the water.</li> <li>- The fuel charging door remains more or less open during the entire operation due to various reasons, mostly human errors</li> <li>- There is no control over fuel firing in combustion chamber</li> </ul> <p>After detailed investigation industry has decided to replace the existing boiler which is not efficient with the efficient 6 TPH capacity boiler with ESP system</p>



	<p>to take care of the air emissions as well. The performance of the existing boiler was evaluated and compared with the efficient boiler for the same amount of steam generation. On the basis of calculations industry placed the order for a new boiler.</p> <ul style="list-style-type: none"> <li>- Reduction in coal consumption: 10-30%.</li> <li>- Reduction in boiler emissions.</li> </ul>  <p><b>Image no. 24: New Boiler under commissioning (left), Old Inefficient Boiler (right)</b> [Source: GIZ-IGEP and GCPC team]</p>
<b>Cross-media effects</b>	None believed likely.
<b>Operation data</b>	The heat transfer is poor due to low heat transfer area and short contact time between flue gas and oil and hence leads to inefficiency and high flue gas losses. The boiler is used for hot water generation required for processing by directly injecting the steam into the water and also to maintain the constant temperature during the dyeing and soaping process as well as for finishing the fabric. The operating efficiency of the existing boilers ranges from 40 % to 90 %.
<b>Applicability</b>	The existing boilers can improve the operating efficiency by semi or full automation of air fuel ratio, draft control as well as fuel charging system, while for new installations the boiler with inbuilt automated system are available.
<b>Economics</b>	The capital cost of the boiler is approx. Rs. 85,00,000 (excluding ESP), while the operating cost remains the same while it will reduce due to consideration of latest technologies and control of the boiler system, the total estimated savings of Rs. 50,00,000 giving payback period of 21 months.
<b>Driving force for implementation</b>	Reduction of coal consumption results in cost savings. Minimisation of energy consumption (and therefore costs) is the main reason to retrofit or replace boiler.
<b>Example plants</b>	V. R. Polyfab, Ahmedabad. The new boiler is commissioned in 2014.
<b>Reference literature</b>	Detailed Project Report on Energy Efficient Boiler by Bureau of Energy Efficiency.

The thorough study of boiler efficiency helped us to decide on replacing the old inefficient boiler with efficient boiler, after techno commercial evaluation provided by the GIZ-IGEP & GCPC team, now we have uninterrupted production and sufficient steam. This project also helped us understand other practices we can follow to make our system efficient and thus applying to gain the economic as well as environment benefits.



**Mr. Sachin Dalwadi, Manager  
V R Polyfab Pvt. Ltd**

### 9. Optimisation of Heat Energy in Jigger Machines

**Description & achieved environmental benefits**

Hot water is required for Dye application, Dye fixation, soaping etc. in a Jigger Dyeing Machine. The Jigger Dyeing Machine is required for Dyeing of cotton fabric or cotton content of the blended fabric. Dyeing of cotton fabric requires hot water at temperatures 80°C to 96°C depending upon the type of dye used. Heat for raising this hot water was drawn from steam raised in boiler by direct injection to water in jigger machine at approx. 3 kg/cm<sup>2</sup>g, thus significant



**Image no. 25: Hot Water Generation & Storage Tank to Supply Hot Water to Jigger Machines**  
[Source: GIZ-IGEP and GCPC team]

amount of heat was required to raise the water temperature also the high steam pressure leads to higher velocity which escapes from the water bath of jigger to atmosphere without delivering the heat and increase the steam consumption further due to losses. Average specific steam consumption at jigger machine was 1.5 to 2 kg of steam per kg of fabric.

The water supplied to the jigger is from condenser cooling water (soft water) of caustic recovery plant at 50°C, thus the water is preheated and will need steam only to raise temperature from 50 °C to average 85°C. This hot water is further heated in closed tank with direct steam injection at 1 kg/cm<sup>2</sup>g pressure only to utilise the full heat content of the steam. The machines are supplied with hot water directly instead of heating water at machines. To maintain the required temperature during the process there are seamless SS coils at bottom of the jigger machines to provide indirect heating through thermic oil available.

- Reduction in coal consumption by 102 tons per year.
- Reduction in fresh water consumption of 30000 KL per year
- Reduction of CETP charges in future for the volume of waste water reduced
- Reduced emissions from boiler

**Cross-media**

The proposed technology, being generic in nature, is not readily available as a

<b>effects</b>	package due to non-use but can be assembled locally as all the components are locally available. Although the operation of control equipment are mostly pneumatic thus results in increased compressed air requirement, as well as the water circulation system needs additional electrical power for pumping resulting in increased electrical energy cost, however the same is being covered by amount of thermal energy saved through the intervention.
<b>Operation data</b>	Steam requirement in Jigger Dyeing is to the tune of 1.5 to 2 Kg steam per Kg of fabric. However, the actual consumption would depend upon the kind of Dye used.
<b>Applicability</b>	The equipment will have to be assembled for Jigger Dyeing Application. However, since the modified mechanism is simple and almost similar products are being used in other application, some change in material / equipments is required to suit the application.
<b>Economics</b>	Capital cost invested for the various modifications was Rs. 13,50,000 with total savings of Rs. 8,70,000, with negligible operating cost giving payback period of 18 months.
<b>Driving force for implementation</b>	Reduced resource consumptions results in cost savings. Moreover emissions are reduced and the payback period of this measure is fair.
<b>Example plants</b>	Mukesh Industries, Ahmedabad. The modification and installation was done in-house by industry in 2011.
<b>Reference literature</b>	[179, UBA, 2001], & Detailed Project Report on Installation of Auto Temperature Controller in Jigger Dyeing Machine by Bureau of Energy Efficiency

## 10. Low Liquor Ration Jet Dyeing Machines

<p><b>Description &amp; achieved environmental benefits</b></p>	<p>Jet dyeing machine dyes the cloth by forcibly contacting the jet flow of dye stuff solution. It executes efficient dyeing in such a manner that the tension on the cloth is decreased as much as possible, and that the cloth dyes evenly with a relatively small amount of dyestuff. Current Jet dyeing machines operate at a liquor ratio of 10:1, thus resulting in excess water consumption and in turn excess wastewater generation. One factor limiting implementation is the high cost of the new machines, which favours use at new facilities rather than as replacements for older machines.</p> <p>Machines of newer designs operate at a liquor ratio of 7:1. These machines usually incorporate low-friction Teflon internal coatings and advanced spray systems to speed rinsing.</p> <p>This measure resulted in the following benefits:</p> <ul style="list-style-type: none"> <li>- Reduced water consumption: <b>30%</b></li> <li>- Reduced electrical power consumption: <b>20%</b></li> <li>- Reduced fuel (coal) consumption: <b>30%</b></li> <li>- Reduced consumption of chemicals &amp; auxiliaries.</li> <li>- Reduction in waste water generation (quality &amp; quantity)</li> </ul>	 <p><b>Image no. 26: Low Liquor Ratio Jet Dyeing Machine</b> [Source: GIZ-IGEP and GCPC team]</p>
<p><b>Cross-media</b></p>	<p>None believed likely.</p>	

<b>effects</b>																																	
<b>Operation data</b>	<p>Table below shows specific input data ranges for cotton dyeing with reactive dyestuffs in a conventional jet operating at L.R. of 1:8 – 1:12 and in the airflow machine described above. The data are derived from measurements taken at production sites.</p> <p>It is worth adding that the model of airflow described in this section is also designed to maintain its low liquor ratio even with the machine well underloaded.</p> <table border="1"> <thead> <tr> <th>Input</th> <th>Unit</th> <th>Conventional jet operating at L.R. 1:8 - 1:12</th> <th>Airflow jet operating at L.R. 1:2 - 1:3 (PES) - 1:4.5 (CO)</th> </tr> </thead> <tbody> <tr> <td>Water (1)</td> <td>(l/kg)</td> <td>100 -150 (3)</td> <td>20 -80 (3)</td> </tr> <tr> <td>Auxiliaries</td> <td>(g/kg)</td> <td>12 - 72</td> <td>4 - 24</td> </tr> <tr> <td>Salt</td> <td>(g/kg)</td> <td>80 -960</td> <td>20 -320</td> </tr> <tr> <td>Dyestuffs</td> <td>(g/kg)</td> <td>5 - 80</td> <td>5 - 80</td> </tr> <tr> <td>Steam</td> <td>(kg/kg)</td> <td>3.6 - 4.8</td> <td>1.8 - 2.4</td> </tr> <tr> <td>Electricity</td> <td>(kWh/kg)</td> <td>0.24 -0.35</td> <td>0.36 -0.42</td> </tr> <tr> <td>Time (2)</td> <td>min</td> <td></td> <td></td> </tr> </tbody> </table> <p>Source: [179, UBA, 2001] Notes (1) Including rinsing (2) Including loading/ unloading (3) The variation in water consumption is to be read as 20 l/kg in the case of PES and 80 l/kg in the case of cellulose. The airflow machine can use as little as 16 l/kg for peroxide bleaching against 32.5 l/kg for a conventional jet and 26.6 l/kg for reactive dyeing/wash-off against 43 l/kg for a conventional jet [176, VITO, 2001]</p>	Input	Unit	Conventional jet operating at L.R. 1:8 - 1:12	Airflow jet operating at L.R. 1:2 - 1:3 (PES) - 1:4.5 (CO)	Water (1)	(l/kg)	100 -150 (3)	20 -80 (3)	Auxiliaries	(g/kg)	12 - 72	4 - 24	Salt	(g/kg)	80 -960	20 -320	Dyestuffs	(g/kg)	5 - 80	5 - 80	Steam	(kg/kg)	3.6 - 4.8	1.8 - 2.4	Electricity	(kWh/kg)	0.24 -0.35	0.36 -0.42	Time (2)	min		
Input	Unit	Conventional jet operating at L.R. 1:8 - 1:12	Airflow jet operating at L.R. 1:2 - 1:3 (PES) - 1:4.5 (CO)																														
Water (1)	(l/kg)	100 -150 (3)	20 -80 (3)																														
Auxiliaries	(g/kg)	12 - 72	4 - 24																														
Salt	(g/kg)	80 -960	20 -320																														
Dyestuffs	(g/kg)	5 - 80	5 - 80																														
Steam	(kg/kg)	3.6 - 4.8	1.8 - 2.4																														
Electricity	(kWh/kg)	0.24 -0.35	0.36 -0.42																														
Time (2)	min																																
<b>Applicability</b>	This machine can be used both for knit and woven fabric and for nearly all types of fibres.																																
<b>Economics</b>	Capital cost of 900 kg/hr machine was Rs. 1.25 crore, with reduced operating cost than conventional jet dyeing machines total savings achieved was of Rs. 18,90,000 per annum giving payback period of 80 months (Excluding cost of chemicals saving & waste water treatment & disposal cost).																																
<b>Driving force for implementation</b>	Cost savings through reduced resource consumption. High productivity and repeatability still remain the main driving forces, followed by savings in water, chemicals and energy consumption.																																
<b>Example plants</b>	KomalTexfab, Ahmedabad. Installed soft flow dyeing machines, supplied by Brazoli, Germany, in year 2008-09.																																
<b>Reference literature</b>	[179, UBA, 2001], [176, VITO, 2001].																																

## 11. Auto Colour Dispensing through Spectrophotometer & Chemical Dispensing System

<b>Description &amp; achieved environmental benefits</b>	<p>The correlation between the formula developed in the lab and the formula used in production cannot be done manually thus resulting in excess chemical usage and increased rework. Reproducing colour accurately and cost-effectively in all of these instances is difficult. Number of problems associated with using traditional manual methods of preparing solutions is as following:</p> <ul style="list-style-type: none"> <li>- Errors can occur when manually calculating the amount of dyestuff, auxiliary and water required when making up solutions.</li> <li>- Manually weighing out the precise amount of the required dye takes time</li> </ul>
--	--

	<p>and skill, and the risk of mistakes in a busy production environment is high.</p> <ul style="list-style-type: none"> <li>- Manually dispensing auxiliaries and water accurately is very time consuming.</li> <li>- Variations in the temperature of water used can affect the stability and accuracy of solutions for certain dyestuffs.</li> <li>- Inaccuracies in the amount of auxiliary added in solutions can affect the stability and reliability of solutions for certain dyestuffs</li> </ul> <p>Pilot measures: An infrared exhaust laboratory-dyeing machine with a fully automated dosing system. Once the on-screen colour is created, the software then, in turn, automatically computes the right colorimetric data. This is the digital "signature" of that colour - and includes the standard colorimetric parameters such as reflectance and L, a, b data. The system accepts measurements from a spectrophotometer in the form of colorimetric data, and instantly transforms that data into visual colour on the screen for evaluation or adjustment.</p> <p>These systems reduce the tendency to overuse environmentally harmful chemicals and, therefore, reduce pollutant loads of discharged effluents. They also reduce handling loss and equipment clean up. In addition, they improve the efficiency and reliability of chemical reactions in the dye bath, ensuring consistent and reproducible results.</p> <p>Chemical usage is reduced (excluding dyes) by at least 10 % and rework of fabric by 3 %. It also reduces labour and overhead costs, increases production, and eliminates the manual handling of chemicals.</p>
<p><b>Cross-media effects</b></p>	<p>There are no cross-media effects to be mentioned</p>
<p><b>Operation data</b></p>	<p>Highly automated systems generally require qualified personnel, but usually one person can easily operate the system.</p> <p>Automated systems for powders are highly sophisticated, especially when very small amounts have to be metered. High precision in dosing is fundamental, especially for powder dyes. Modern automated dosing systems can dose amounts of powders as small as 0.8 g.</p> <p>Data from a textile dyehouse (size 5500 t/year) show the following improvements before and after the installation of an automated dosing and dispensing system for chemicals.</p> <p>Automated laboratories can reduce reworking to 2 – 3 % of total production.</p>



**Image no. 27: The auto dispensing system , Spectrophotometer and IR dyer**  
 [Source: GIZ-IGEP and GCPC team]

	<table border="1"> <thead> <tr> <th></th> <th>Before</th> <th>After</th> </tr> </thead> <tbody> <tr> <td>Seconds</td> <td>1.6 %</td> <td>0.9 % (43 % reduction)</td> </tr> <tr> <td>Reworks</td> <td>4.5 %</td> <td>3.7 % (17 % reduction)</td> </tr> <tr> <td>Chemicals reduced costs</td> <td></td> <td>11.2 %</td> </tr> <tr> <td>Labour reduced cost (in the dyehouse)</td> <td></td> <td>10 %</td> </tr> <tr> <td>Increased dye machine efficiency</td> <td></td> <td>5 %</td> </tr> </tbody> </table>		Before	After	Seconds	1.6 %	0.9 % (43 % reduction)	Reworks	4.5 %	3.7 % (17 % reduction)	Chemicals reduced costs		11.2 %	Labour reduced cost (in the dyehouse)		10 %	Increased dye machine efficiency		5 %
	Before	After																	
Seconds	1.6 %	0.9 % (43 % reduction)																	
Reworks	4.5 %	3.7 % (17 % reduction)																	
Chemicals reduced costs		11.2 %																	
Labour reduced cost (in the dyehouse)		10 %																	
Increased dye machine efficiency		5 %																	
<b>Applicability</b>	<p>Typical automated dosing and dispensing techniques described in this section are applicable to both new and existing installations. However, exception is made for highly sophisticated techniques such as dosing systems based on the colour-on-demand principle and automated laboratories, which are still very expensive and as a consequence more suitable for large installations.</p> <p>Space availability may represent an issue in existing companies, especially for the automation of dyes. Whereas liquid chemicals are easy to automate due to the limited number of chemicals used in the process, some companies may regard the high number of dyes as a limitation due to lack of space and higher investment costs required.</p>																		
<b>Economics</b>	The capital cost invested by industry was Rs. 2,00,00,000, with minimum operating and maintenance cost, the total savings achieved by industry is Rs. 62,64,000 per annum giving simple payback of 3.5 years.																		
<b>Driving force for implementation</b>	Chemical usage is reduced (excluding dyes) by at least 10 % and rework of fabric by 3 %, this results in cost savings and less negative environmental impact. The main driving forces for implementation are increased reproducibility and productivity along with health and safety requirements defined by legislation.																		
<b>Example plants</b>	M/s. KomalTexfab, Ahmedabad. The auto dispensing system (Aral, Israel), spectrophotometer (gretagmacbeth) and IR dyer (Copower) were installed by industry in year 2011.																		
<b>Reference literature</b>	[179, UBA, 2001], [171, GuT, 2001], [76, Colorservice, 2001], [289, Comm., 2002].																		

## 12. Installation of Variable Frequency Drive in Jet Dyeing Machine

### Description & achieved environmental benefits

In Jet Dyeing higher pressure of 3.5 kg/cm<sup>2</sup> is required to ensure uniform dyeing of the fabric and also causes fabric movement whereas lower pressure of 1.5 kg/cm<sup>2</sup> is required for creating movement of the fabric during cycle other than dyeing cycle. Due to non-availability of any mechanism for varying the pressure, the pump is made to operate on much more than the required pressure or is throttled to get the required pressure. In case of operating at higher pressure, electricity is unnecessarily wasted.



**Image no. 28: Installed VFD for Jet Dyeing Machine Pumps**

[Source: GIZ-IGEP and GCPC team]

	<p>The system proposed is retro fitment of a VFD armed with PLC based control gear to the Jet Dyeing Machine so as to implement time based and requirement oriented change in RPM of the pump. The PLC based system can be integrated with existing control gear or can be installed as a package.</p> <ul style="list-style-type: none"> <li>- Reduction in electricity consumption</li> <li>- Better process control</li> </ul>
<b>Cross-media effects</b>	VFDs are the electronic equipment and needs to be installed area which are dust free as well as lower temperature thus some plants need to provide additional cooling arrangement which will increase the electricity consumption, although the additional cost will be covered by savings from VFDs.
<b>Operation data</b>	Currently, the pump runs at full rpm even though pressure requirement is lower in other than heating cycle. As per the typical cycle adopted Polyester Dyeing, pressure of inside the machine is between 1.5 to 3.5 Kg/cm <sup>2</sup> for 55 minutes only out of a total cycle of 3 hours whereas the pump keeps running at full rpm and the pressure is controlled manually.
<b>Applicability</b>	The technique is applicable to both existing and new installations.
<b>Economics</b>	Capital cost of one 12.5 HP VFD is Rs. 30,000, operating costs is negligible, giving total savings of Rs. 55,000 per annum with return of investments of 7 months.
<b>Driving force for implementation</b>	Reduction of electricity consumption and better process control for better quality, quick return of investment.
<b>Example plants</b>	Rinkoo Processors, Ahmedabad, The VFDs were installed on 11 nos. pumps of Jet Dyeing Machine in 2010.
<b>Reference literature</b>	Cluster Manual - Pali Textile Cluster by Petroleum Conservation Research Association under BEE SME program & Detailed Project Report. On Installation of Variable Frequency Drive in Jet Dyeing Machine Pumps by Bureau of Energy Efficiency.

### 13. Flash Steam Recovery of Drying Range to Preheat Boiler Feed Water

<b>Description &amp; achieved environmental benefits</b>	<p>A typical dryer machine has 12 to over 30 steam cylinders. A typical 16 cylinder dryer requires 110 kg steam input per hour for 2400 m/hr fabric running rate, i.e., approximately 0.30 kg of steam per kg of water evaporated. The steam after condensation comes out of the dryer cylinder at approx. 2 kg/cm<sup>2</sup>g pressure which then is collected in an open tank, due to sudden change in pressure some of the heat from condensate is used to evaporate water and thus generation of flash steam. This flash steam goes into atmosphere as waste. The industry is having 4 nos. of drying ranges with average 45 KL/day condensate generation from each range.</p> <p>The industry designed a simple system to recover this flash steam and raise the temperature of boiler feed water to reduce the fuel input at boiler by supplying heated water. A additional tank is constructed above the condensate recovery tank and flash steam generated is allowed to be passed through coils in the top tank to heat the water, when the water temperature reaches the required feed water temperature an automatic valve opens the flow to condensate tank and the heated water with hot condensate is pumped to the boiler feed water tank.</p>
--	--

	<ul style="list-style-type: none"> <li>- Reduction in coal consumption by 510 tons per year.</li> <li>- Reduction in fresh water consumption of 3375 KL per year due to recovery of flash steam</li> <li>- Reduced emissions from boiler</li> </ul> <div style="display: flex; justify-content: space-around; align-items: center;"> <div data-bbox="527 346 1006 808" style="text-align: center;"> </div> <div data-bbox="1023 346 1372 808" style="text-align: center;"> </div> </div> <p><b>Image no. 29: Schematic showing Flash Steam Heat Utilisation to Generate Hot Water</b> [Source: GIZ-IGEP and GCPC team]</p> <p><b>Image no. 30: Actual Flash Steam Heat Recovery System</b> [Source: GIZ-IGEP and GCPC team]</p>
<b>Cross-media effects</b>	The collection of flash steam and use to generate hot water results in increased pumping power, however the same is covered by the thermal energy as well as water recovered through the system.
<b>Operation data</b>	The typical consumption of a 250 kg capacity Jet Dyeing Machine is 150 kg Steam per hour and most of the units do not have systems to recover flash steam. Typically the quantity of flash steam is upto 10 % of total condensate generated.
<b>Applicability</b>	The proposed technique, being generic in nature, is applicable for existing as well as new installations. Flash steam recovery is a part of the steam distribution and utilization system and comes as an optional unit with steam system.
<b>Economics</b>	Capital cost for the modification was Rs. 1,00,000 with savings due to reduction in fuel consumption of Rs. 35,67,000 per annum with negligible operating cost giving payback period of 10 days.
<b>Driving force for implementation</b>	Cost savings and very quick payback period.
<b>Example plants</b>	Mukesh Industries, Ahmedabad. The system for heat content utilisation from flash steam is designed In-house by the industry and was implemented in 2012, the schematic of the system is shown above.
<b>Reference literature</b>	[171, GuT, 2001]



## 14. Heat Losses Optimisation at Cylinder Drying Range

<p><b>Description &amp; achieved environmental benefits</b></p>	<p>Side plates of drying range can be insulated with more durable (life &amp; properties) mineral/rock wool, which can result in reduction of steam consumption. This non-combustible mineral wool is a composition of inorganic components which are melted in a furnace, and then spun and bonded with a resin to form various insulation products. Mineral wool comes in various forms. Meter sections come in preformed sections and vary in density from 160 kg/m<sup>3</sup> to 185 kg/m<sup>3</sup>, depending on the pipe size. The Wired Mattress, rigid and semi-rigid board and flexible felt comes in a matt form, or reinforced mat depending on the requirements.</p> <p>Also, there are heat resistive coatings available in market which are polymer based coatings with special thermal insulation properties and are applicable for the hot surfaces where the installation of conventional insulation is not practical due to various reasons. These heat resistive coatings claims reduction of heat losses upto 20 % and surface temperature reduction upto 40 %.</p> <ul style="list-style-type: none"> <li>- Reduction in steam consumption: 5-10%</li> <li>- Reduction in boiler emissions.</li> <li>- Production area working conditions will improve</li> <li>- Safety for workers will improve</li> </ul> <div data-bbox="1058 520 1333 823" data-label="Image"> </div> <div data-bbox="1058 827 1365 926" data-label="Caption"> <p><b>Image no. 31: Insulated Side Plates of Cylinder Dryer</b> [Source: GIZ-IGEP and GCPC team]</p> </div> <div data-bbox="483 1014 837 1276" data-label="Image"> </div> <div data-bbox="854 1150 1287 1255" data-label="Caption"> <p><b>Image no. 32: Thermal Image of Uninsulated Side Plate of Cylinder Dryer</b> [Source: Case study under KAEFER-GIZ partnership project in Paper sector]</p> </div>
<p><b>Cross-media effects</b></p>	<p>The replacement of glass wool insulation with mineral or rock wool leads to generation of waste glass wool which is hazardous waste and need to be disposed as per hazardous waste rules.</p>
<p><b>Operation data</b></p>	<p>A typical 16 cylinder dryer requires 110 kg steam input per hour for 2400 m/hr fabric running rate, i.e., approximately 0.30 kg of steam per kg of water evaporated. The side plates of cylinders, non-covered cylinder surfaces and non-insulated piping emit heat to the surrounding area and thus loss of energy. The major challenges for insulating the side plates of a cylinder dryer are following:</p> <ul style="list-style-type: none"> <li>- Cylinder dryers rotates at 50-60 rpm</li> <li>- Normally industries insulate with glass/mineral wool</li> <li>- Water resistance of mineral wool is very low and thus gaining moisture by insulation makes it conductive to heat loss</li> <li>- Normally insulation peel off within 2-3 month of installation</li> <li>- Due to low moisture resistance and holding of moisture within insulation promotes corrosion</li> </ul>
<p><b>Applicability</b></p>	<p>This technique is generally applicable to both new &amp; existing industries.</p>
<p><b>Economics</b></p>	<p>Capital costs of the insulation will be Rs. 35,000 for 12 m<sup>2</sup> surface area, No operating costs involved and estimated saving is Rs. 1,16,000 with payback period of 4 months.</p>

<b>Driving force for implementation</b>	Reduction of steam consumption and emission. Better worker safety and quick payback period.
<b>Example plants</b>	M/s Mukesh Industry, Ahmedabad
<b>Reference literature</b>	Energy Efficiency in India, Moving India's SMEs towards a sustainable future – Case study under KAEFER-GIZ partnership project in Paper sector.

**15. Optimisation of Exhaust by Controlling the Exhaust Humidity with Automation**

<p><b>Description &amp; achieved environmental benefits</b></p>	<p>In Cotton Printing, Stenter is used before printing but after pre-treatment. In case of Polyester or PC Dyeing, stenter is used twice, once for heat setting and then again for final finish. Only 5.4% of heat given to stenter is utilized in heating the fabric in case of Heat Setting. Heat gained by fabric in any typical stenter operation is 4.6% only. It is further evident that approx. 95% stenters is used for the purpose of moisture evaporation, released to atmosphere or wasted.</p> <p>Instruments are available which automatically control the dampers to maintain exhaust humidity within this specified range thereby cutting air losses without significantly affecting fabric throughput. By installing the exhaust moisture controlling system (retrofit), the moisture % age required to be present in the finished fabric is set and optionally if required speed of the fabric is varied so as to attain exact moisture % age. Proposed equipment is available with Vibha Power Solutions Pvt. Ltd., Indore, M.P.</p> <ul style="list-style-type: none"> <li>- Reduction in consumption of electrical power: 5-10%</li> <li>- Reduction in consumption of fuel (coal): 20%</li> <li>- Reduction in thermic fluid heater emissions.</li> <li>- Reduction in process time.</li> </ul> <div data-bbox="479 1134 1383 1543" data-label="Image"> </div> <p><b>Image no. 33: Picture showing Installed Exhaust Humidity Controller at Stenter</b> [Source: GIZ-IGEP and GCPC team]</p>
<p><b>Cross-media effects</b></p>	<p>None believed likely</p>
<p><b>Operation data</b></p>	<p>As per a case study, 30% energy saving was achieved by control of exhaust air moisture. A minimal 5% reduction in Energy can safely be considered by way of exhaust moisture measurement and control system. In the Exhaust Moisture control System, a sensor senses moisture quantity in the exhaust and depending upon the settings of PLC, gives signal to the VFD installed in the pump so as to ensure rated moisture % all the time.</p>
<p><b>Applicability</b></p>	<p>Described technique is applicable to new installations. For existing equipment, the applicability is in some cases limited (Stenters used for polyester fabric).</p>

<b>Economics</b>	Capital costs of the equipment is Rs. 1,65,000, No operating costs involved, Estimated saving is Rs. 1,85,000 (@ 5 % savings) with return of investments in 11 months.
<b>Driving force for implementation</b>	Reduction of resource consumption and emission. Faster process time and quick payback period.
<b>Example plants</b>	M/s Mukesh Industries, Ahmedabad.
<b>Reference literature</b>	Detailed Project Report on Installation of Exhaust Humidity Control System in Stenters by Bureau of Energy Efficiency.



## References

1. Report 20130610\_Baseline Study\_Textiles.Feb\_GIZ\_DD
2. GCPC Report on 'Cleaner Production in Textile Industries, 2011',
3. Impact of Textile in Environmental Issues & Environmental Legislation (Part I) By: Karthik T. and Gopalakrishnan D.
4. Productivity and Competitiveness of Indian Manufacturing Sector: Textile and Garments Report by NPC (National Productivity Council).
5. Human Resource and Skill Requirements in the Textile Industry: A Study on mapping of human resource skill gaps in India till 2022 by NSDC (National Skill Development Corporation).
6. BAT Guidance Note on Best Available Techniques for the Textile Processing Sector (1st Edition) by EPA (Environmental Protection Agency).
7. Environmental Standards in the Textile and Shoe Sector - A Guideline on the Basis of 'The BREFS – Best Available Techniques Reference Documents of the EU' By Umweltbundesamt.
8. Comprehensive Industry Document (COIND) for Textile Industry by CPCB (Central Pollution Control Board).
9. Environmental Guidance Manual Sector: Textile Projects by RPCB (Rajasthan Pollution Control Board).







## Report prepared by

Deutsche Gesellschaft für  
Internationale Zusammenarbeit (GIZ) GmbH

### Registered offices in Germany

Friedrich-Ebert-Allee 40  
53113 Bonn, Germany  
T +49 228 44 60-0  
F +49 228 44 60-17 66

Dag-Hammarskjöld-Weg 1-5  
65760 Eschborn, Germany  
T +49 61 96 79-0  
F +49 61 96 79-11 15

E [info@giz.de](mailto:info@giz.de)  
I [www.giz.de](http://www.giz.de)

### Registered office in India

Indo-German Environment Partnership  
(IGEP) Programme  
Deutsche Gesellschaft für  
Internationale Zusammenarbeit (GIZ) GmbH  
B5/2, Safdarjung Enclave  
New Delhi 110029, India  
T: +91 11 49495353  
F: +91 11 49495391  
E [contact@igep.in](mailto:contact@igep.in)  
I : [www.igep.in](http://www.igep.in), [www.giz.de](http://www.giz.de)

### Responsible

Dr. Dieter Mutz, Programme Director, GIZ-IGEP

### Author

Mr Raghu Babu Nukala, Senior Technical Advisor & Programme Coordinator, GIZ, IGEP  
Mr Nitesh Patel, Mr Debajt Das, Mr Philip Jain

### Acknowledgements

German Federal Environmental Agency (Umwelt Bundes Amt]  
Gujarat Cleaner Production Centre, Gandhinagar  
Gujarat Pollution Control Board

New Delhi, June 2015



Deutsche Gesellschaft für  
Internationale Zusammenarbeit (GIZ) GmbH  
Indo-German Environment Partnership Programme  
B-5/2, Safdarjung Enclave  
New Delhi 110029  
T + 91 11 4949 5353  
F + 91 11 4949 5391

E [contact@igep.in](mailto:contact@igep.in)  
I [www.igep.in](http://www.igep.in), [www.giz.de](http://www.giz.de)